

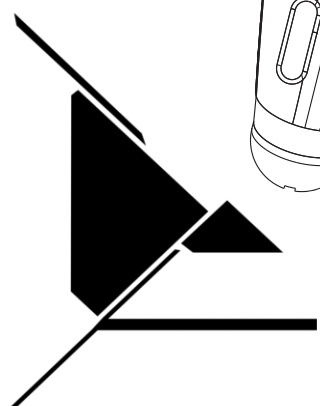

Elysium EL18

User Manual

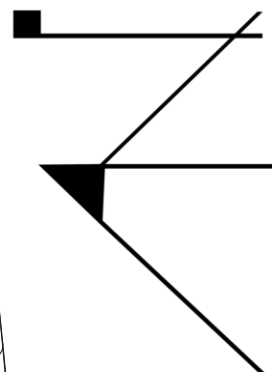
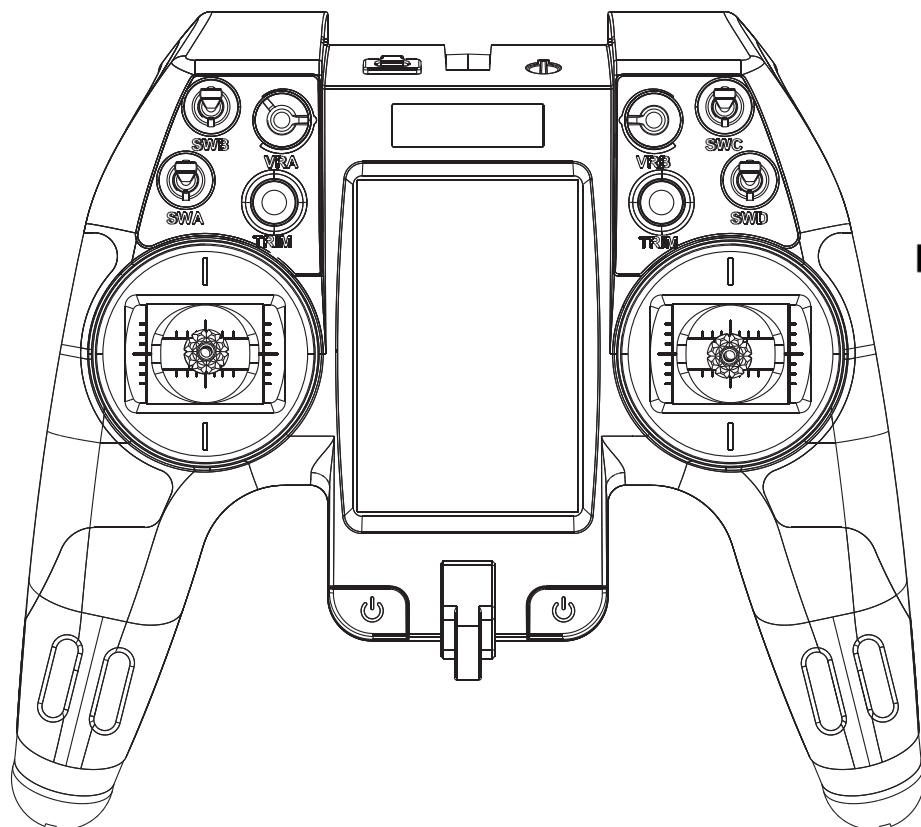

FLYSKY

Touching Infinity

Copyright ©2022 Flysky Technology co., Ltd

 **WARNING:**
This product is only for 15 years old or above



微信公众号



Bilibili



Website



Facebook





Thank you for purchasing our products.

Read the manual carefully to ensure your personal safety as well as the safety of your equipment. If you encounter any problems during using, please refer to this manual first. If the problem is still not resolved, please contact the local dealer directly or contact the customer service staff via the website below:

<http://www.flysky-cn.com>

The following documents can be downloaded at the official Flysky website:

1. EL18 user manual
2. EL18 Quick Start Guide
3. Disclaimer & Warning

Users are advised to read the Disclaimer & Warning first, then the EL18 Quick Start Guide and the EL18 user manual.

Table of Contents



1. Safety	5
1.1 Safety Symbols	5
1.2 Safety Guide	5
2. Battery Safety Instructions	6
3. Product Description	7
3.1 System Features	7
3.2 Transmitter Overview	8
3.3 Receiver Overview	11
3.4 Antenna	11
4. Before Use	12
4.1 Transmitter Battery Installation	12
4.2 Receiver Installation	12
4.3 RF Module Adapter Installation	13
4.4 Left and Right Gimbal Swap	13
5. Operation Guide	15
5.1 Basic Setting Guidelines	15
5.2 Language Selection	15
5.3 Power On	16
5.4 Binding	16
5.5 Power Off	17
5.6 Neck Strap Hook and SD Card Slot	17
5.7 Warning After Turning On	17
5.8 Upgrading RF Firmware	18
5.9 Upgrading Transmitter Firmware	19
6. Radio Interface	20
7. Function Settings	21
7.1 Select Model	21
7.1.1 Create A Model	21
7.1.2 Create New Label	21
7.2 Channel Monitor	21
7.3 Model Settings	22
7.3.1 Model Name	22
7.3.2 Model Image	22
7.3.3 Use Global Function	22
7.3.4 ADC Filter	22
7.3.5 Internal RF	22
7.3.7 Trainer	24
7.3.8 Timer1	24
7.3.6 External RF	24
7.3.9 Timer2	26
7.3.10 Timer3	26
7.3.11 Preflight Checks	26
7.3.12 Trims	27

7.3.13 Throttle	27
7.3.14 HELI Setup.....	28
7.3.15 Flight Modes.....	28
7.3.16 Inputs	28
7.3.17 Mixes	30
7.3.18 Outputs	32
7.3.19 Curves	33
7.3.20 Global Variables	34
7.3.21 Logical Switches.....	34
7.3.22 Special Functions	35
7.3.23 Telemetry	36
7.4 Radio Settings.....	37
7.4.1 Tools.....	37
7.4.2 SD-HC Card.....	37
7.4.3 Radio Setup.....	38
7.4.4 Themes	40
7.4.5 Global Functions	40
7.4.6 Trainer.....	40
7.4.7 Hardware	41
7.4.8 Version	42
7.5 Screen Settings	43
7.6 Reset	43
7.7 Statistics	44
7.8 About EdgeTX.....	44
8.Product Specifications	45
8.1 Transmitter Specifications	45
9. Package Contents	46
10.Certifications	47
10.1 DoC	47
10.2 CE Warning.....	47
10.3 FCC Statement	47
10.4 Environmentally friendly disposal	48
10.5 UKCA Compliance Statement.....	48

1.Safety

1.1 Safety Symbols

Pay close attention to the following symbols and their meanings. Failure to follow these warnings could cause damage, injury or death.

 Danger	<ul style="list-style-type: none">• Not following these instructions may lead to serious injuries or death.
 Warning	<ul style="list-style-type: none">• Not following these instructions may lead to major injuries.
 Attention	<ul style="list-style-type: none">• Not following these instructions may lead to minor injuries.

1.2 Safety Guide

- Do not use the product at night or in bad weather like rain or thunderstorm. It can cause erratic operation or loss of control.
- Do not use the product when visibility is limited.
- Do not use the product on rain or snow days. Any exposure to moisture (water or snow) may cause erratic operation or loss of control.

- Interference may cause loss of control. To ensure the safety of you and others, do not operate in the following places:

Near any site where other radio control activity may occur

Near power lines or communication broadcasting antennas

Near people or roads

On any body of water when passenger boats are present



- Do not use this product when you are tired, uncomfortable, or under the influence of alcohol or drugs. Doing so may cause serious injury to yourself or others.
- The 2.4GHz radio band is limited to line of sight. Always keep your model in sight as a large object can block the RF signal and lead to loss of control.
- Never grip the transmitter antenna during operation. It significantly degrades signal quality and strength and may cause loss of control.
- Do not touch any part of the model that may generate heat during operation, or immediately after use. The engine, motor or speed control, may be very hot and can cause serious burns.

- Misuse of this product may lead to serious injury or death. To ensure the safety of you and your equipment, read this manual and follow the instructions.
- Make sure the product is properly installed in your model. Failure to do so may result in serious injury.
- Make sure to disconnect the receiver battery before turning off the transmitter. Failure to do so may lead to unintended operation and cause an accident.
- Ensure that all motors operate in the correct direction. If not, adjust the direction first.
- Make sure the model flies within a certain distance. Otherwise, it would cause loss of control.



- The EL18 system uses EdgeTX open source firmware. Official updates will be posted on our official website from time to time. If you modify or use unofficial software, the system may encounter out-of-control or error. Our company will not accept legal responsibility caused by unofficial software!

2. Battery Safety Instructions



Do not use batteries that are damaged, aged or have abnormalities such as leaks.

Do not short circuit the battery.

Do not repair, modify, disassemble, crush or puncture the battery.

Do not allow contact with water.

Do not charge or store the battery in high temperatures or in direct sun light.

Store the battery in a cool, dry environment.

Do not charge under the following conditions:

- Covered or without ventilation.
- In extremely cold or hot conditions.

Do not use around flammable gases or liquids.

Do not bend, stretch or pull on the power cord.

- The power cord may be damaged by fire, heat, electric shock etc.
-

The battery should be stored in a location that is not accessible to infants and toddlers.

Be sure to charge the battery before flying.

- If a battery leak accidentally comes in contact with skin, clothing, etc., wash it immediately with water. If it comes in contact with eyes wash immediately. Seek medical attention if necessary.



When not in use for a long time, remove the battery from the transmitter and store it in a dry environment.

Do not throw used batteries into the garbage can, etc., and dispose of them according to the treatment methods specified in each area.

Use only the battery specified by the manufacturer.

Take care to prevent the battery from falling, bumping or vibrating.

If the battery is damaged, stop using it immediately.

3. Product Description

The Elysium, referred to as EL18, is a transmitter using EdgeTX system with a 3.5in IPS color touch-screen. The EL18 has 2 RF options, internal RF and external RF. the internal RF, namely AFHDS 3 supports up to 18 channels of output, the external RF supports up to 32 channels of output. The system comes with the Tmr receiver, making it a perfect system for FPV.

3.1 System Features

AFHDS 3

AFHDS 3 (third-generation automatic frequency hopping digital system) is a newly developed digital wireless system with independent intellectual property rights by FLYSKY. It is compatible with one-way and two-way real-time data packet transmission and transparent data stream transmission. In other words, this system has advantages of both AFHDS 2A and WS2A wireless system. It equips with a brand-new 2.4G chip, stable and reliable connection, good real-time performance, and supports various configurations. Bring you the optimal configuration for multi-scenario application performance.

Compatible with One-way/two-way Real-time Data Transmission	The system supports one-way and two-way connections. When the transmitter is working in one-way transmission way, the receiver can receive data from the transmitter. When the transmitter is working in two-way transmission way. The receiver can receive data from the transmitter and the transmitter can also receive data from the receiver, as well as the information cross from the temperature and speed sensor modules.
Data Transparent Transmission	The independent data transparent transmission module is built into RF system, which can realize data transmission via transmitter and transparent transmission. It can be used for data transmission of flight control.
Intelligent RF Configuration	To set the parameters which affect RF transmission distance, speed and anti-interference, such as numbers of channels, resolution, bandwidth and receiver sensitivity. The system can be set according to different application requirements to obtain the most suitable performance.
Multi-channel Frequency Hopping	This systems bandwidth ranges from 2.402GHz to 2.480GHz. Set intelligent RF configurations according to your required, it can avoid or reduce the interference from other transmitters with the same frequency via different configurations, different time of powering on the transmitter, various patterns to the hopping frequency and various using frequency spots.
Unique ID Recognition System	Each transmitter and receiver has it's own unique ID. Once the transmitter and receiver have been bound, they will save the each other's ID and only connect with each other. When the syetem is working,if the IDs are matched with each other, then the connection will be connected, otherwise, there is no connection between transmitter and receiver. This unique ID recognition syetem resists the interference so as to make the system stabler and more reliable.
Low Power Consumption	It is built using highly sensitive, low power consumption components. And it works in the way of interval data transmission to improve transmitting efficient effectively and extend the working time of the battery distinctly, while it consumes as little as one tenth the power of a standard FM system.

EdgeTX

EdgeTX is an open source operating system for transmitter. EdgeTX is very powerful. Users can configure the transmitter according to their own needs, making transmitter more comprehensive and higher performance.



微信公众号



Bilibili



Website



Facebook

3.2 Transmitter Overview

Front View

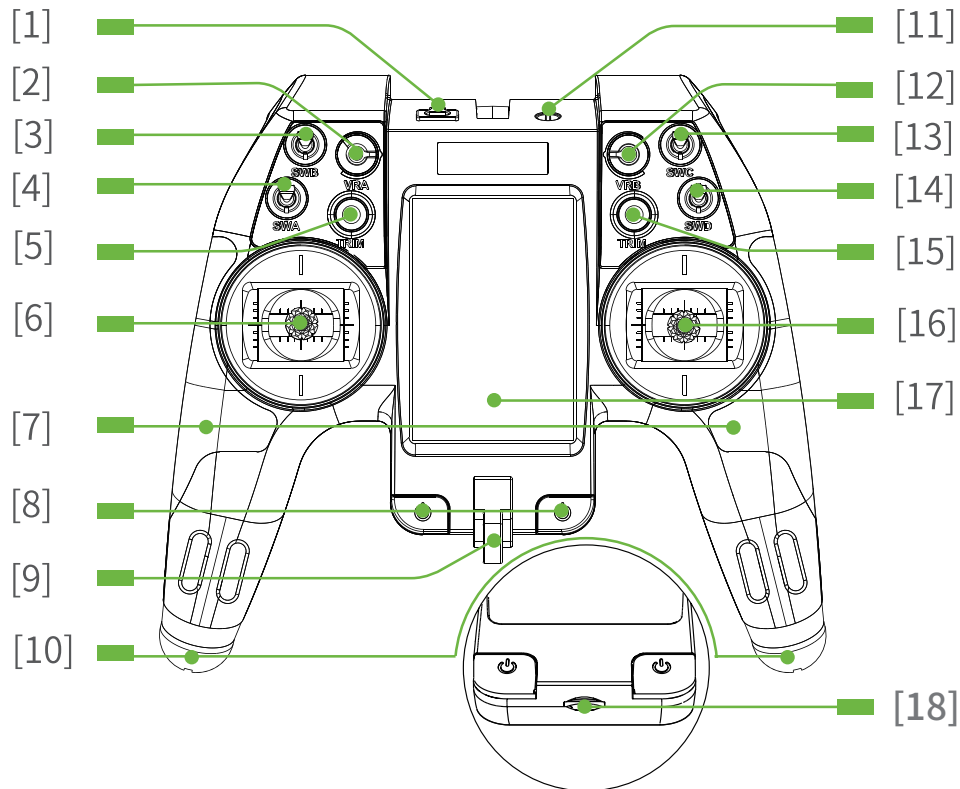

- | | |
|---------------------|---------------------------------|
| [1] Type-C USB Port | [10] Battery Compartment Covers |
| [2] VRA | [11] Trainer Port |
| [3] Switch B | [12] VRB |
| [4] Switch A | [13] Switch C |
| [5] TRIM | [14] Switch D |
| [6] Left Stick | [15] TRIM |
| [7] Grip | [16] Right Stick |
| [8] Power Switches | [17] Touch-screen |
| [9] Neck Strap Hook | [18] SD Card Slot |



Back View

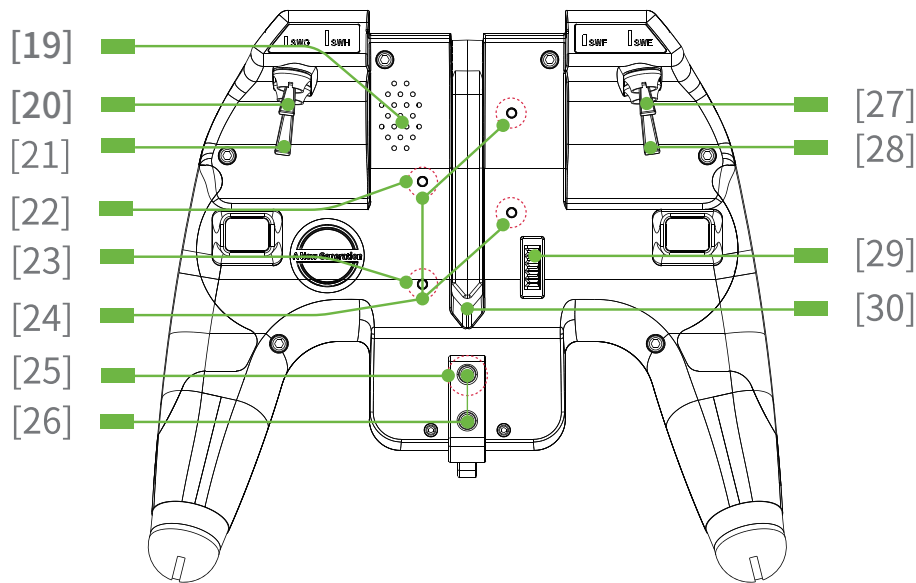

- | | |
|---|---|
| [19] Speaker | [25] DFU Button |
| [20] Switch G | [26] Screw Holes for Fixing Neck Strap Hook |
| [21] Switch H | [27] Switch F |
| [22] RF Firmware Forced-update Button | [28] Switch E |
| [23] Type-C Connection Toggling Button | [29] Stealth I/O RF Module Interface |
| [24] Screw Holes for Fixing RF Module Adapter | [30] Rotatable Antenna |

Switches/Buttons/Ports

Type-C USB Port: For charging, simulator or update.

VRA: Knob

VRB: Knob

Switch A: Short 2 position switch

Switch B: Short 3 position switch

Switch C: Short 2 position automatic return switch

Switch D: Short 2 position switch

Switch E: Long 2 position automatic return switch

Switch F: Short 3 position switch

Switch G: Short 3 position switch

Switch H: Long 2 position automatic return switch

TRIM (Left) /TRIM (Right): Trim for aileron , elevator, throttle and rudder

Left Stick: Non self-centering

Right Stick: Self-centering

Trainer Port: For trainer function

RF Firmware Forced-update Button: For forced updating the RF module firmware

Type-C Connection Switch Button: For switching the Type-C to connect the transmitter MCU or RF module MCU

DFU button: To update the transmitter firmware

Stealth I/O: To connect to the external RF module

Antenna: Omnidirectional antenna, foldable



微信公众号



Bilibili



Website



Facebook

DFU Button

The DFU button is located in the screw hole marked in the green circle in the picture below. The DFU button is used to update the EL18 firmware.

Note: Do not operate the DFU button with sharp or metal objects to prevent damage to its internal structure.

For the steps on use ([To be updated...](#))

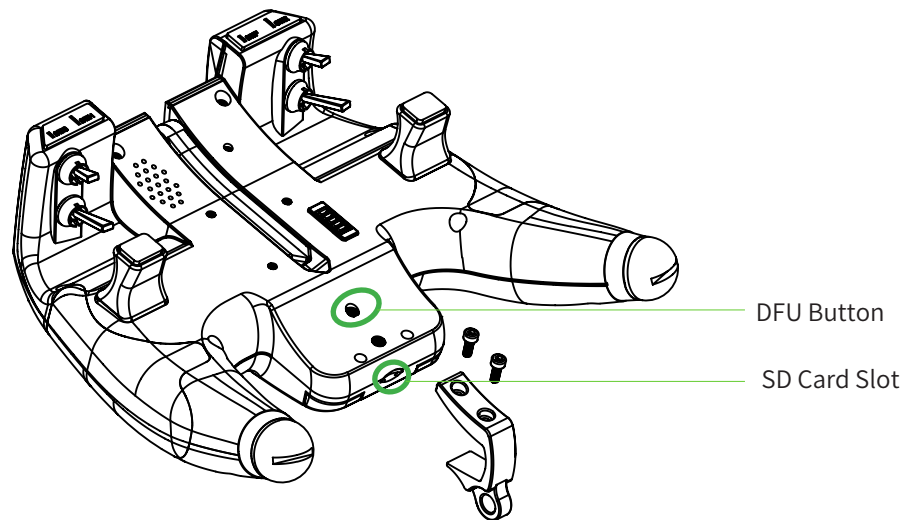

Type-C Connection Toggling Button

To toggle the Type-C connection to RF MCU or the transmitter MCU. When the RF firmware needs to be forced upgraded, press this button to toggle the Type-C connection to RF MCU first.

Note: By default, the Type-C connects to the transmitter MCU.

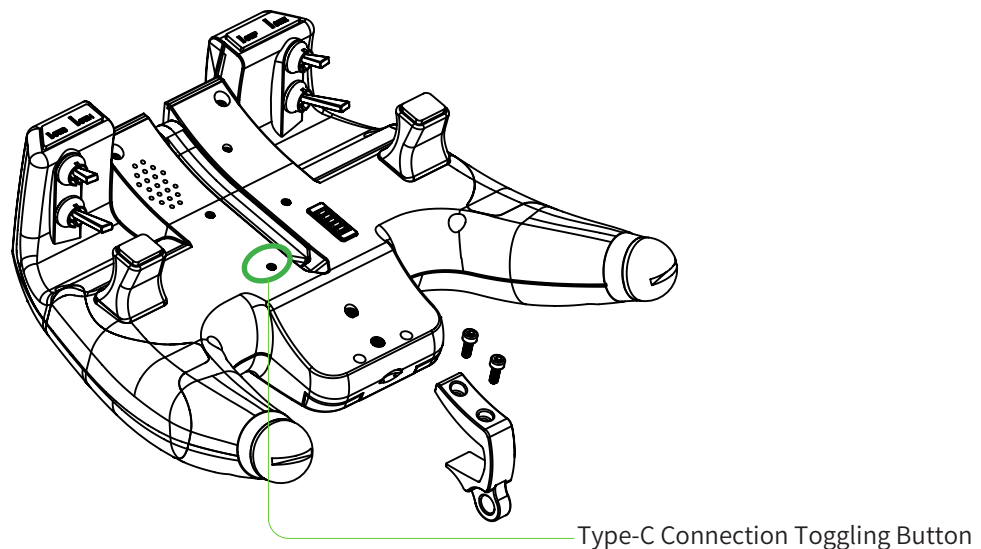

3.3 Receiver Overview

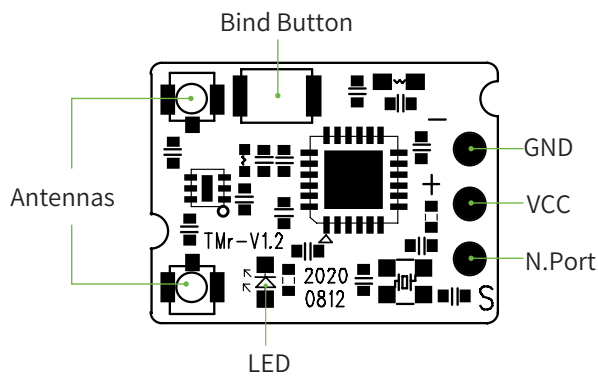

3.4 Antenna

Warning Do not hold the antenna during use in order to prevent signal quality loss.

Attention To ensure signal quality, the antenna should be perpendicular to the model body.

Attention Do not pull or bend the antenna.

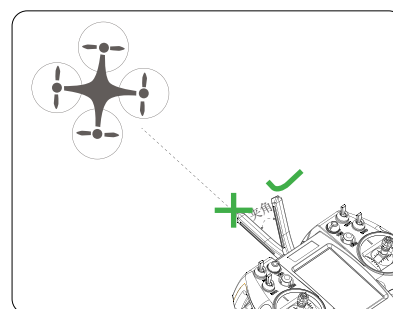
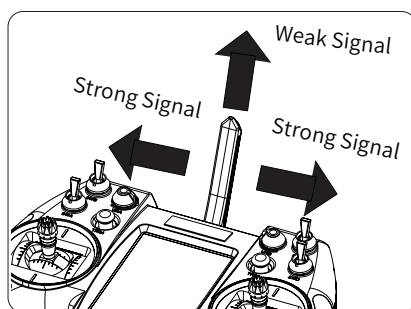
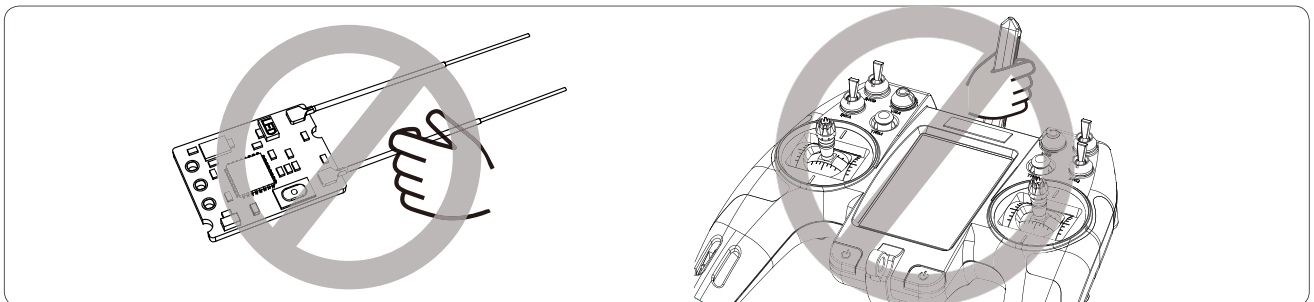

微信公众号



Bilibili









Website



Facebook

4. Before Use

Before operation, please follow the instructions in this chapter to install the battery and connect the device.

	Danger	• Use only the battery specified by the manufacturer.
	Danger	• Do not open, disassemble, or repair the battery yourself.
	Danger	• Do not squeeze, puncture, or touch the metal terminals of the battery.
	Danger	• Do not expose the battery to high temperatures or liquids.
	Danger	• Take care to prevent the battery from dropping, bumping or vibrating.
	Danger	• Store the battery in a dry, cool environment.
	Danger	• If the battery is damaged, stop using it immediately.

4.1 Transmitter Battery Installation

- Unscrew both battery compartment covers from the transmitter handles.
- Insert 2 18650 batteries into the battery compartments respectively.
 - Please pay attention to the anode and cathode of the battery, refer to the diagram for correct installation.
 - Use two batteries to ensure the power supply capacity of the battery.
- Screw the battery compartment covers back into place.

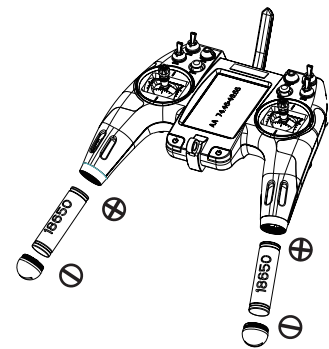



4.2 Receiver Installation

Make sure that the receiver is mounted in an appropriate location within the model, to ensure a stable signal, maximum range and to mitigate external interference, follow these guidelines:

Pay attention to the following when installing the receiver:

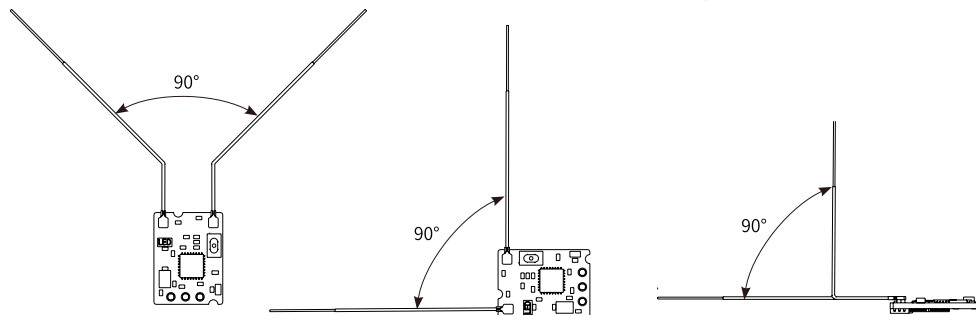
- Make sure the receiver is not installed near ESCs or other sources of electrical noise.
- Keep the receiver's antennas away from conductive materials such as carbon or metal. To ensure normal function make sure there is a gap of at least 1cm between the antenna and the conductive material.
- Make sure that the two antennas of the receiver are fixed at 90 degrees to each other (as shown below).



	Attention	• Do not connect the receiver to the power supply during these steps to avoid damage.
---	------------------	---



4.3 RF Module Adapter Installation

Two RF module adapters are included with the transmitter to match different RF module. To install the suitable RF module adapter according to the actual RF module.

Follow the steps below to install the RF adapter.

1. There are 4 screw holes and one port at the back of the transmitter, shown as below. The screw holes are used to fix the RF module adapter to the transmitter and the port is used to connect the interface of the RF module adapter.
2. Align the holes of the RF module adapter up to the holes on the transmitter, and make sure the interface of the RF module adapter insert the port entirely, then tighten the screws.

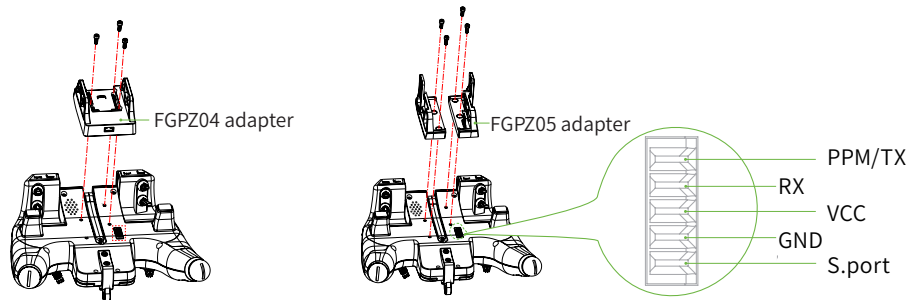

4.4 Left and Right Gimbal Swap

The EL18 is able to switch stick functions as needed. When the EL18 is shipped from the factory the left stick is set up for throttle with non self-centering. Follow the steps below to set right stick to non self-centering if the right stick is going to set up for throttle.

1. Remove the 2 hand grips and switch pads, then remove all 10 screws on the bottom of the transmitter apart from the screws in the finger grips. Lift gently to pull the cover apart.

Attention Don't pull the front cover and back cover too far apart to avoid damaging cables.

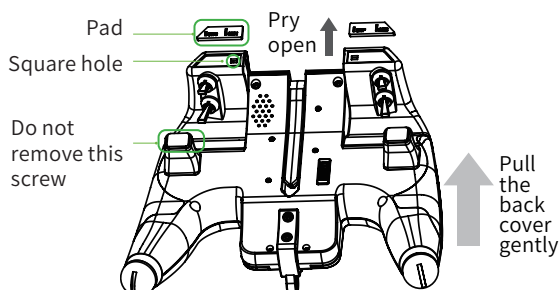

2. Left and right gimbals shown below for clarity.

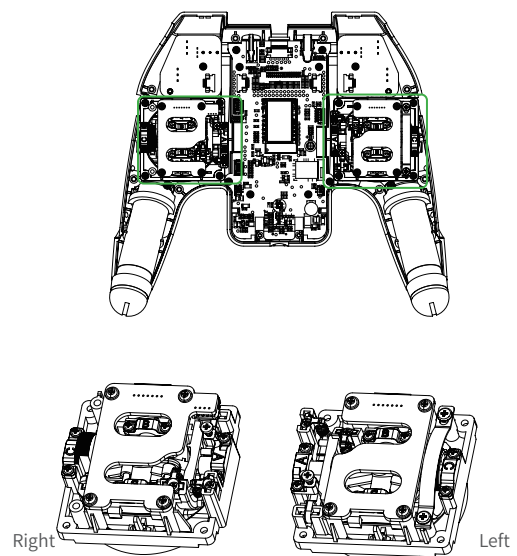

微信公众号



Bilibili



Website



Facebook

3. Take out the assembly and loosen the screws marked in the figure.

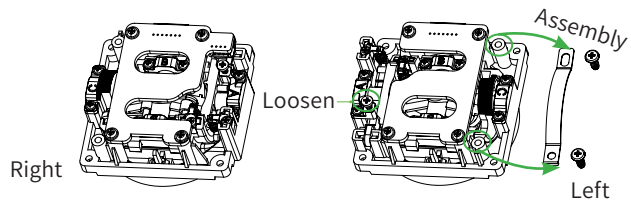

4. As shown, attach the assembly, removed from the left assembly, to the right assembly, and tighten the screws marked in the figure.

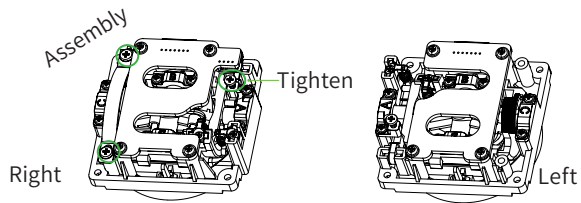

5. Replace the back of the transmitter and tighten the screws, then replace the grips.

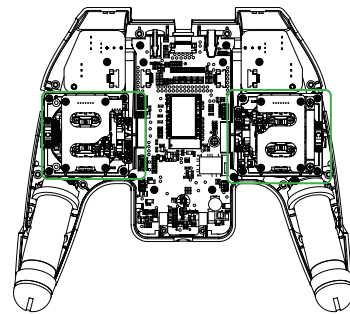

5. Operation Guide

After the preparation is complete, you can follow the instructions in this chapter to get started.

5.1 Basic Setting Guidelines

If you use the open-source system for the first time, you can set up the transmitter according to the following basic setting guidelines:

Language Selection → Mode Selection → Stick Mode → Assign Channel → Stick Calibration → Bind → Protocol Setting → Failsafe.

- Language Selection: Refer to "5.2 Language Selection".
- Model Selection: Refer to "7.1 Select Model".
- Stick Mode: Select the appropriate stick mode according to your habit. Refer to "7.4.3 Radio Setup → Default Channel Order and Mode".
- Assign Channel: Set the channel-related functions. Refer to "7.3.16 Inputs and 7.3.17 Mixes".
- Stick Calibration: Refer to "7.4.7 Hardware → Inputs → Calibration".
- Bind: Bind the transmitter with the receiver. Refer to "7.3.5 Internal RF → Bind".
- Protocol Setting: Set the output signal type of the receiver interface. Refer to "7.3.5 Internal RF → Type → Modules Option".
- Failsafe: Set the failsafe. Refer to "7.3.5 Internal RF → Failsafe Mode".

5.2 Language Selection

By default, the transmitter is installed with one language. If you need to change the language, you need to update the firmware. To change Chinese to English, update the Chinese firmware to English firmware. Refer to "5.9 Updating Transmitter Firmware".



微信公众号



Bilibili



Website







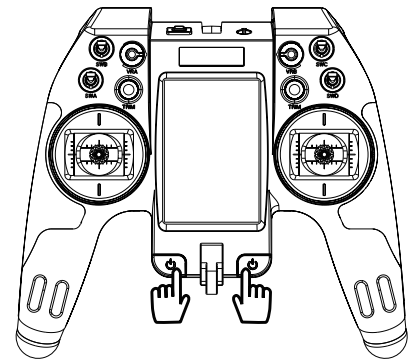

Facebook

5.3 Power On

Follow the steps below to turn on the transmitter:

1. Make sure all the switches are at their highest positions and the throttle is at its lowest position.
2. Press and hold both of the Power Switches until the screen turns on.



 Warning	• The system is now active, please use extreme caution during use.
 Warning	• For your safety, make sure the throttle is at its lowest position and switches at their highest.
 Danger	• When in use make sure not to fly beyond the maximum range.
 Attention	• External signal sources may affect signal quality.
 Danger	• Check each channel is working correctly before use to avoid any unexpected accidents.

5.4 Binding

TMR receiver supports binding in two-way, follow the steps below to finish.

1. Enter the "Model Settings" menu, then select "Internal RF" to enter the submenu. After setting the corresponding mode, ie FLYSKY AFHDS 3, suitable type(Classic 18ch, Classic 10ch, Routine 18ch, Fast 8ch or Lora 12ch) and Module options(output signal type of receiver), tap the "Bind" to put the transmitter into bind state.
2. Press and hold the receiver Bind button while powering on the receiver, release the BIND button after receiver is powered on or powering on the receiver first, then press and hold the Bind button for 3 seconds, the LED of the receiver will flash rapidly, indicating the receiver is in bind mode;
3. The binding process is finished when the LED of the receiver is solid on.
4. Check to make sure the transmitter and the receiver functions are working correctly, repeat steps 1 to 3 (binding process) if any problems arise.

Note: For one-way mode, after the receiver LED becomes slow flashing, then put the transmitter to exit the binding state. At this time, the receiver LED is solid on, indicating that the binding is successful.

These steps only apply to the Elysium and it's included receivers. For other receivers please refer to their user manual.

As the product is constantly updated, please visit the FLYSKY website for the latest transmitter and receiver compatibility documents.



5.5 Power Off

Follow the steps below to turn off the transmitter:

1. Turn off the receiver.
2. Press and hold both Power Switches until the screen turns off.

 Danger	• For safety always power off the receiver before the transmitter.
---	--

5.6 Neck Strap Hook and SD Card Slot

To access the card slot, need to remove the Neck Strap Hook first. The steps are as below:

1. loosen the two hex screws on the back Neck strap hook.
2. Remove the Neck strap hook to expose the SD card slot.
3. Press the SD card inwards and release to remove.

Note: The EL18 transmitter needs to have an SD card installed for the firmware to work correctly.

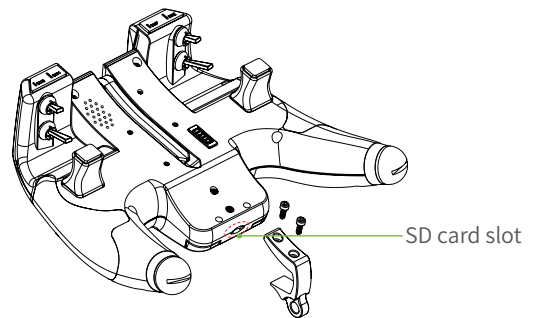

5.7 Warning After Turning On

Press and hold the Power Switches to turn on the transmitter. Before entering the radio interface, the system will check the position of the throttle stick and controls, as well as other starting conditions. There will be a corresponding error warning which needs to be cleared by user operation or skipped by pressing any key, when the conditions do not match.

Throttle Warning

If the throttle stick is not in the lowest position when turning on, this warning will appear. Then put the throttle stick to the lowest position or press any key to skip.

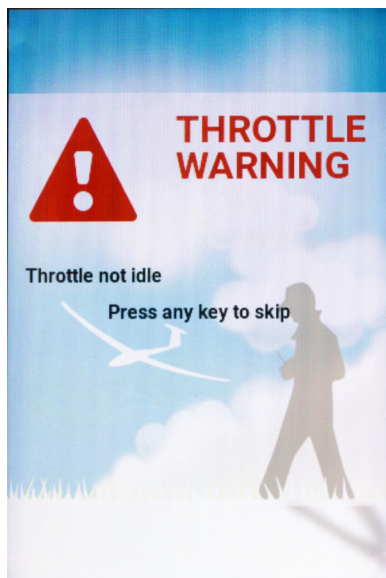

Control Warning

This is a warning that the controls are not in their default position. ↑ is the default position.



微信公众号



Bilibili



Website



Facebook

5.8 Upgrading RF Firmware

The RF module firmware of EL18 can be updated. Follow the steps below to upgrade.

1. Download the latest version firmware at PC side, then open it.
2. Use USB cable to connect the transmitter and the receiver, then select "USB Storage(SD)".
3. Press Type-C Connection Toggling Button to toggle the Type-C connection to RF module MCU, meanwhile the RF LED will light up.
4. At PC side, click Upadte to start the updating.

It can upgrade the RF module firmware in forced update mode. Follow the steps belllow to update.

1. Download the latest firmware at PC side, then open it.
2. Use USB cable to connect the transmitter and the receiver, then select "USB Storage(SD)".
3. Press Type-C Connection Toggling Button to toggle the Type-C connection to RF module MCU, meanwhile the RF LED will light up.
4. Press RF Firmware Forced-update Button to enter force-update mode.
5. At PC side, click Upadte to start the updating.

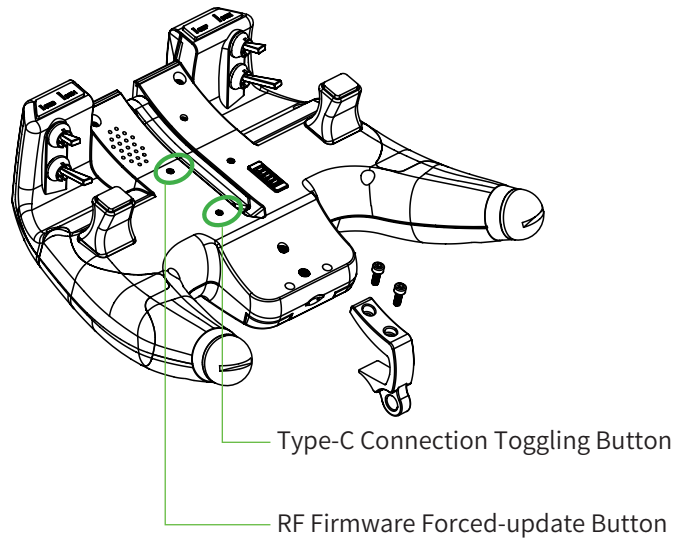

5.9 Upgrading Transmitter Firmware

Follow the steps below to update the firmware of the transmitter:

1. Download the latest version firmware at PC side.
2. Use USB cable to connect the transmitter and the receiver, then select "USB Storage(SD)".
3. Copy the firmware downloaded to FIRMWARE folder of "SD-HC Card".
4. Unplug the USB cable, then turn off the transmitter.
5. According to the directions as shown, push both TRIM buttons at the same time while pressing the both Power Switches for 2S, then release them, at the time, the transmitter screen lights up. The transmitter enters firmware updating state, as shown in Pic 1.
6. Press R TRIM button to access the "FIRMWARE" folder, then push upwards or downwards to select the firmware you desired, as shown in Pic 2.
7. Press and hold the R TRIM button for a while to start the update. The progress bar will appear on the screen, as shown in Pic 3.
8. Press L TRIM button to return after the progress has been finished, as shown in Pic 4. Push R TRIM button downwards to select "Exit", then exit the update state by pressing R TRIM button

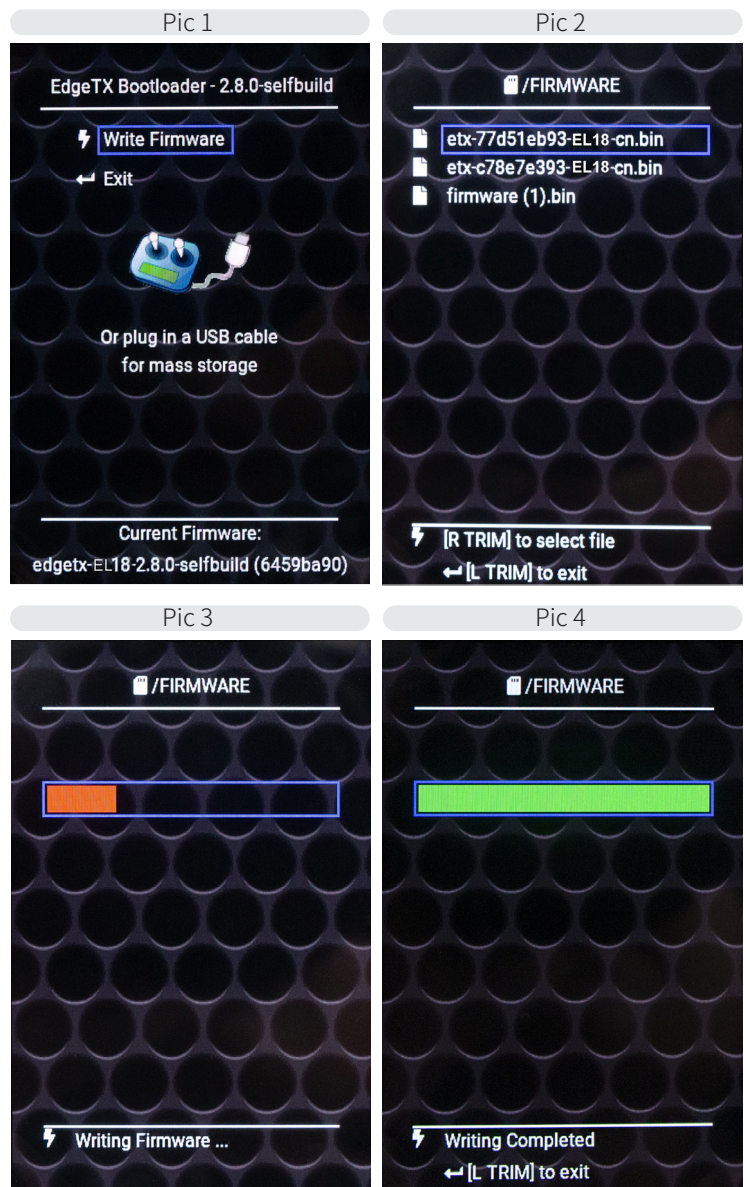
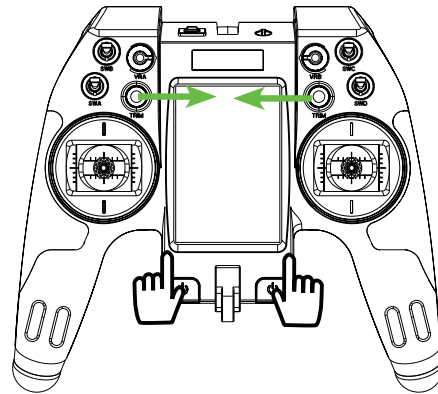

微信公众号



Bilibili



Website



Facebook

6. Radio Interface

This is an introduction about the transmitter's main interface.

The main interface includes the function icons, such as Select Model, Channel Monitor, Model Settings, Screens Settings, Reset Telemetry, Statistics and About EdgeTX.

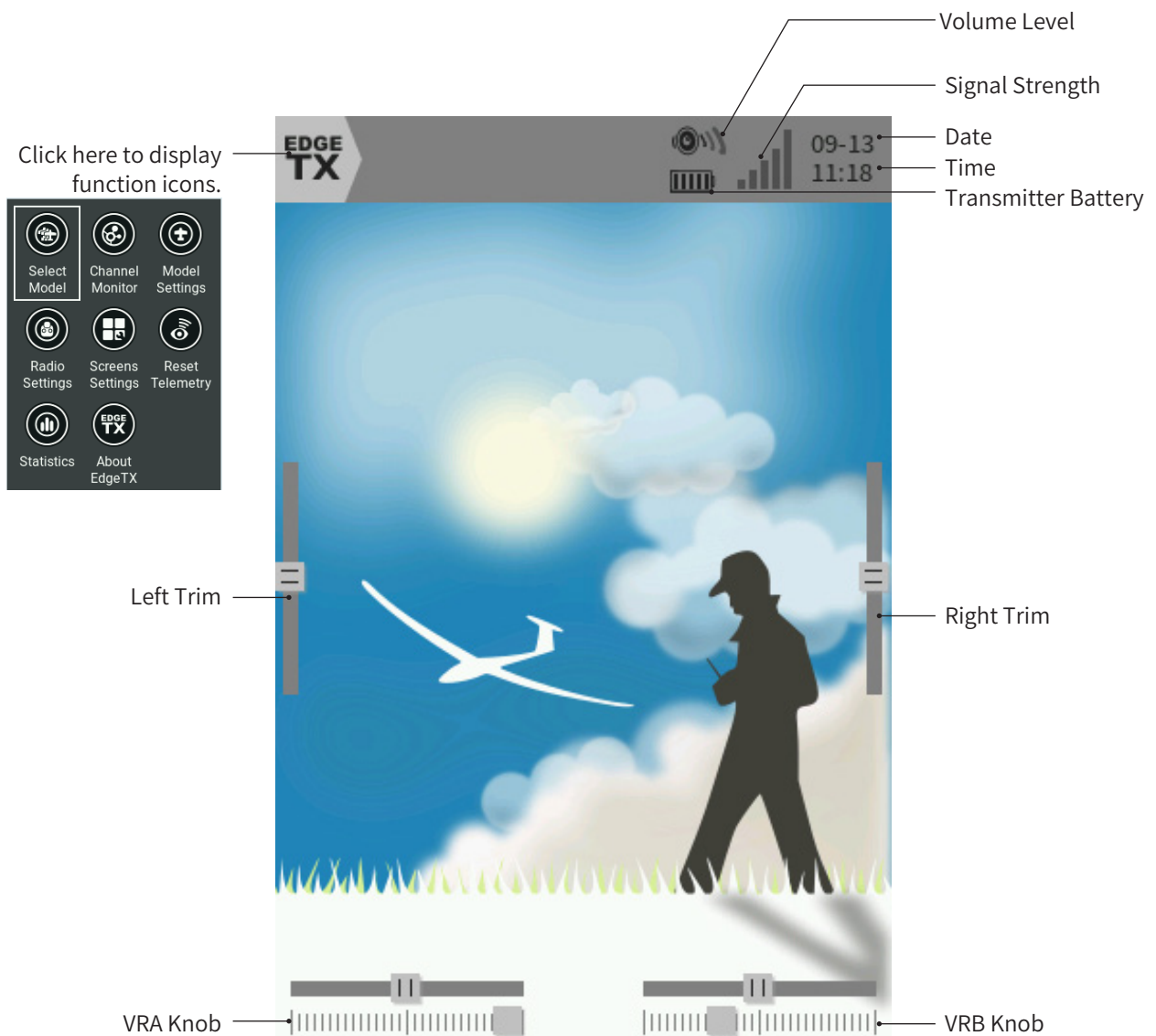

7. Function Settings

This chapter introduces the related settings of functions.

7.1 Select Model

Used to create, duplicate, delete or select model, as well as creating new label. Manage the existing models by labels function.

7.1.1 Create A Model

Create a new model.

Click "New Model" to create a model.

You can select, duplicate, delete model or edit labels.

Select Model

Select the model that is controlled by the current transmitter.

Duplicate Model

With the duplicate function, you can create a new model by using the data of the currently selected model. You can use this function to copy the existing model data when setup up a new model, and then modify different contents. The repeated setup can be avoided.

Delete Model

Delete the selected model. The current model in use cannot be deleted.

7.1.2 Create New Label

You can rename the model label, as well as labeling the established models.

Click "New Label" to create a label.

Edit Label

Click model → "Edit labels" → Select a label

7.2 Channel Monitor

By using this function, you can view the output of each channel and the status of the logic switch.

Channel Monitor

View the output of each channel. EdgeTX can output up to 32 channels.

Each channel displays two travel bars in total. One is "Output view", indicating the actual output of the channel, and the other is "Mixes view", indicating the output calculated by superimposing various setup functions such as curve, mixes, etc. The output of "Mixes view" is not the same as "Output view".

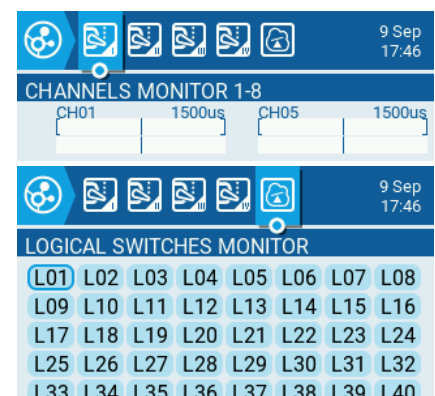
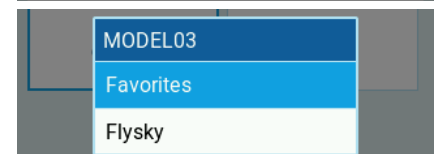
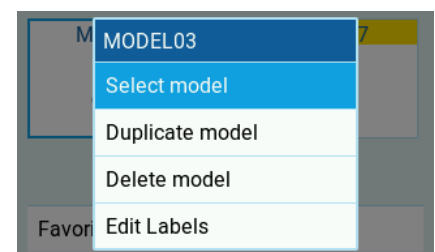
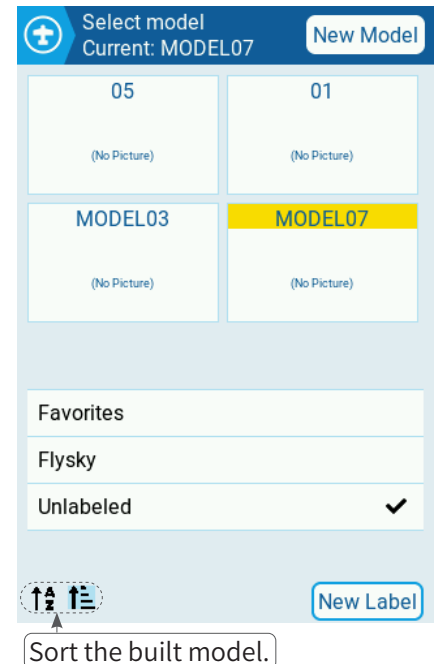

微信公众号



Bilibili



Website



Facebook

7.3 Model Settings

7.3.1 Model Name

It is used to change the model name. You can view it on the model interface after the change is completed. You can enter a maximum of 15 characters.

7.3.2 Model Image

Modify the picture corresponding to the model. The picture will be displayed in the "Model selection" after the modification is completed. The picture is also displayed when the model is selected as a widget in the main interface.

The format of the picture is recommended to be: PNG format, with a resolution of 320x480.

7.3.3 Use Global Function

Set whether the model can be controlled by use global function.

7.3.4 ADC Filter

(To be updated...)

7.3.5 Internal RF

Model

With the built-in radio frequency Flysky AFHDS 3 (Third Gen Automatic Frequency Hopping Digital System) protocol, EL18 is compatible with Flysky 3rd generation receivers.

It is used to set the communication protocol of the transmitter. Select "OFF" to disable the internal radio frequency module. Select "FLYSKY" to enable the internal radio frequency module. This can be used to bind Flysky AFHDS 3 receivers (TM4/FTr16S/FT8B/FTr8B). For more information about it, visit the official website of Flysky Technology: <https://www.flyskycn.com/>

Module Status

Display the current connection status of transmitter and receiver. "Disconnected" means the transmitter is not connected to the receiver, or the receiver is not detected. "Connected" means the transmitter and receiver are connected.

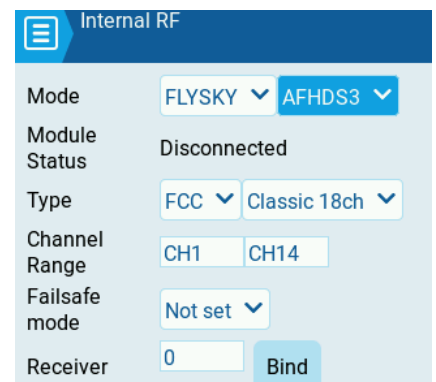
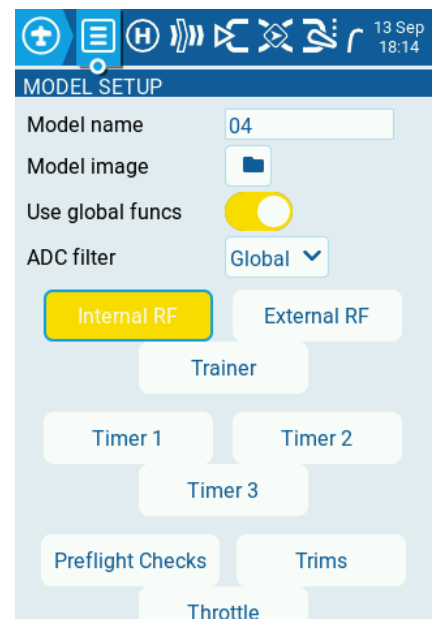

Type

Select the transmitter and receiver connection parameters. There are classic and enhanced receivers in Flysky 3rd generation receivers. For the two types of receivers, you need to select the appropriate type.

"FCC or CE" Set the transmit power of the current transmitter. Legal regulations vary with countries/regions. Please choose the appropriate transmitter power according to the relevant legal information.

"Classic 18ch" Adapt to AFHDS 3 Classic receivers, such as FTr10/FTr4/FTr16S. There are 18 channels for communications.

"Classic 10ch" Adapt to AFHDS 3 Classic receivers. There are 10 channels for communications.

"Routine 18ch" Bind the Enhanced receivers, with a moderate communication distance. There are 18 channels for communications.

"Fast 8ch" Bind the Enhanced receivers, with fast communication speed in a short distance. There are 8 channels for communications.

"Lora 12ch" Bind the Enhanced receivers, with super anti-interference and moderate communication distance. There are 12 channels for communications.

"Modules Option" Set PWM frequency, as well as the output signal type of the receiver, namely one of PWM/PPM/SBUS/i-BUS2/iBUS IN/iBUS OUT.

Channel Range

You can set the number of receiver output channels. By default, it is CH1-CH14. You can set the number of channels required by the model.

Receiver

Set the receiver ID. [\(To be updated...\)](#)

Bind

Click "Bind" to make the transmitter enter the binding state. The "Binding" can be displayed in the "Module Status" state, indicating that the transmitter enters the binding state.

Failsafe Mode

used to set the output channel value of the receiver after the receiver loses the signals. Five states can be set: "Not set", "Hold", "Custom", "No pulses", and "Receiver".

"Custom" Users can set the failsafe preset output value according to the failsafe output requirement of the model. On the setup interface, the blue travel bar indicates the output value of the corresponding position of the current control, and the red travel bar indicates the output value of the failsafe already set.

Steps:

1. Click "Custom" to set it to failsafe, then click "Set".
2. Toggle the stick and control to the preset value position.
3. Click "Import all values of current channel". The transmitter will use this value as the failsafe output value

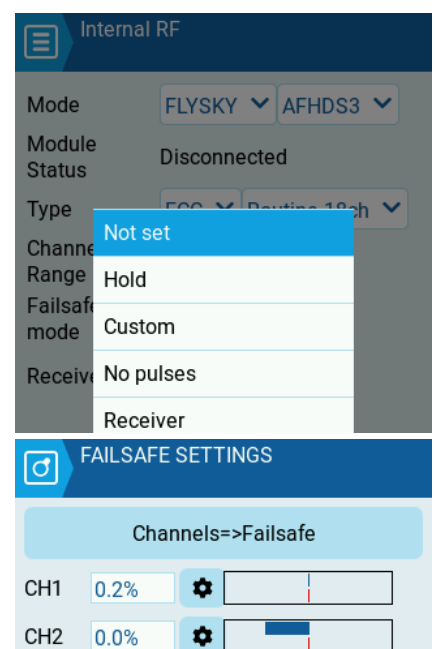
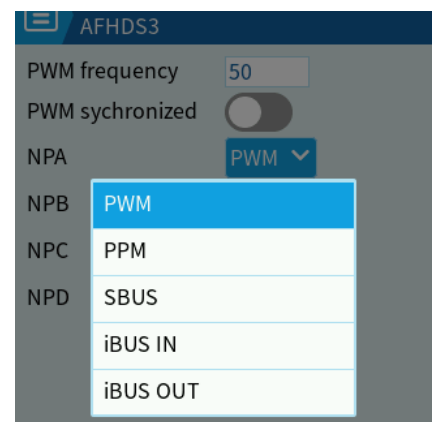
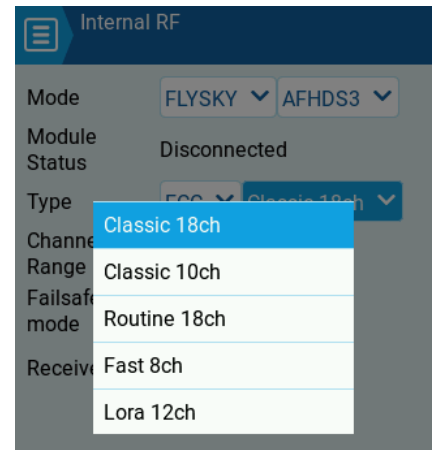

微信公众号



Bilibili



Website



Facebook

4. Test.

On the custom failsafe setup interface, to set a separate channel, you can also click  of the corresponding CH.

7.3.6 External RF

Set the model channel range, radio frequency protocol, failsafe mode, refresh rate, and PPM frame rate of the external RF module.

EdgeTX supports the use of multiple RF modules. Each RF module supports different communication protocols and setup methods. For specific information, refer to the instruction manual of the corresponding RF module.

If another RF module is used, it should match a receiver that is compatible with the RF module. In this way, the binding can be completed.

In the setup of the internal RF or external RF, the delay can be properly reduced by setup the appropriate channel range, PPM frame and other parameters.

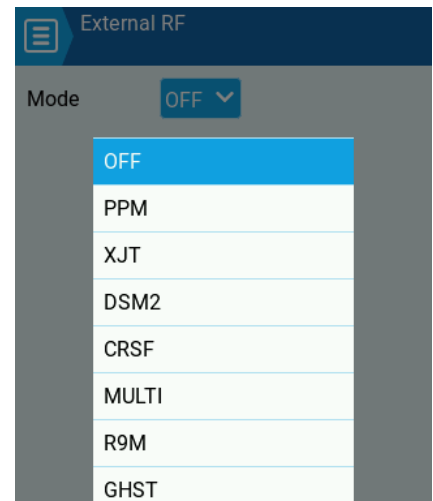

7.3.7 Trainer

This function is used to set the master/slave mode of the trainer port. Four modes are available for selection.

When the "Master/Jack" is selected, the transmitter outputs trainer control signals to the model as the trainer mode, and student control signals are input from the audio jack.

When the "Slave/Jack" is selected, control signals of this transmitter are output to the trainer port from the audio jack. When the transmitter is connected to the simulator with a dongle, you need to select this option.

In this mode, you can set the channel range and PPM frame in the same way as the RF setup.

In the PPM frame setup options, you can set the frame length, pulse width and signal type respectively.

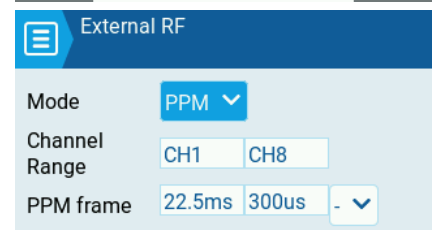
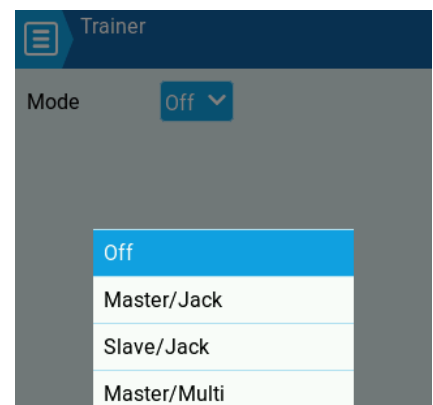

7.3.8 Timer1

Name

Name the timer with up to 8 characters.

Mode

Set the mode and switch for triggering the timer. You can set 6 groups of modes in total. A combination of different controls is used to control the start and stop of the timer. There are up-timer and down-timer.

Different timer modes can meet various flight condition requirements.

"OFF" Switch off the timer.

"ON" After the ON switch of the timer is triggered, it is not affected by

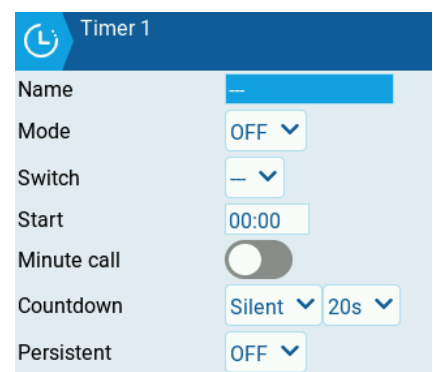

other conditions. The timer starts the counting. When the ON switch returns to the initial position, the counting pauses.

"Start" After the ON switch of the timer is triggered, it is not affected by other conditions. The timer starts the counting. When the ON switch returns to the initial position, the counting does not pause.

"Throttle" After the "ON" switch of the timer is triggered, when the throttle is not in the lowest position, the timer starts counting. When the ON switch of the timer returns to the initial position or the throttle returns to the lowest position, the counting pauses.

"Throttle%" After the "ON" switch of the timer is triggered, when the throttle is in the highest position, the timer starts counting, to calculate the time of full throttle. When the ON switch of the timer returns to the initial position or the throttle is not in the full-throttle position, the counting pauses.

"Throttle Start" After the "ON" switch of the timer is triggered, when the throttle is not in the lowest position, the timer starts counting. When the ON switch of the timer returns to the initial position, the counting pauses.

Note: The timer can be reset in "Reset"function.

Switch

Position switch: You can assign a toggle switch control or telemetry data control on the transmitter as the ON switch of the timer.

The " ↑ ", " ↓ " and "-" nearby the position switch indicate the highest, lowest and middle positions respectively. After selecting the target position of the position switch, you need to click the screen for confirmation.

When the timer mode setup is completed, toggle the position switch. For example, "SD ↓ " means the timer is enabled when SWD is in the lowest position.

Start

It is used to set the duration of the countdown. For example, if it is set to "01:00" to enable the timer, the timer starts counting down from 1 minute when the timing condition is triggered.

Minute Call

If this option is selected, the transmitter will broadcast once every one minute.

Countdown

It is used to set the transmitter broadcast mode and prompt time before the end of the countdown when the countdown times out.

The countdown prompt is divided into four modes: "Silent", "Beeps", "Voice", and "Haptic".

Note: "Voice" mode refers to the default sound in the system when there is no special setup.

Countdown Prompt Time

There are four modes: "5 seconds", "10 seconds", "20 seconds", and "30

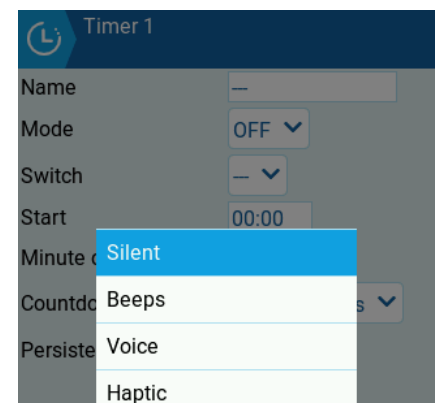
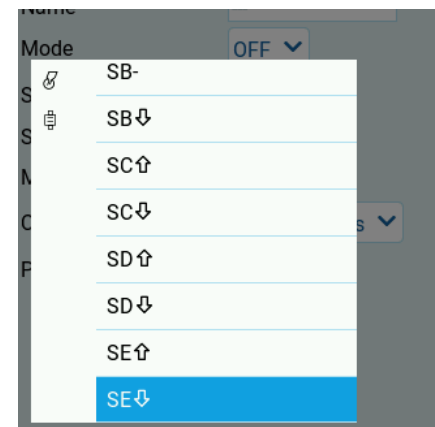
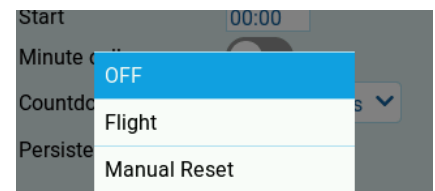
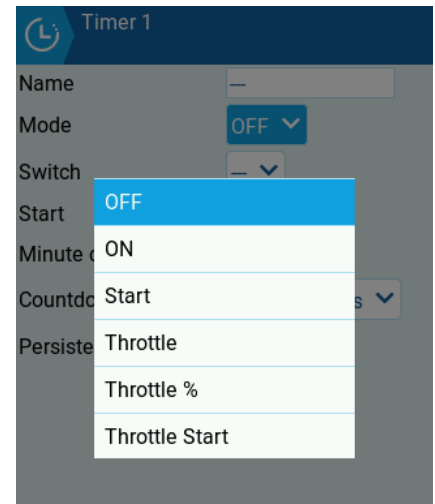

微信公众号



Bilibili



Website



Facebook

seconds". If it is set to "10 seconds" is set, the transmitter will play the prompt when there are only 10 seconds left. If "Voice" is selected, it will play "10-9-8-...3-2-1"

Persistent

It is used to set the current timing state of the timer, that is, the storage state by the shutdown or model change. There are three types: "OFF", "Flight", and "Manual Reset". (To be updated...)

7.3.9 Timer2

Refer to 7.3.8 Timer 1 on how to setting and using.

7.3.10 Timer3

Refer to 7.3.8 Timer 1 on how to setting and using.

7.3.11 Preflight Checks

Display checklist

If a text file with the same name as the model is in the MODELS folder of the SD card, the transmitter will recognize it as a model check list. If this option is selected, the file will be displayed automatically.

Throttle State

When this item is selected, it will check whether the throttle is in the lowest position upon power-on. If the throttle is not in the lowest position, the system will give an alarm. If this item is not selected, the check is not performed.

Custom Position

Turn on this function, you can customize the initial position of the throttle, and the system will be detected at power on with this value as the minimum throttle detection value.

Switch Position

It is used to set the initial position detection upon power-on. There are two states: one is to be detected yellow background, and the other not to be detected blue background. Players can define the position of the switch for power-on detection as required.

Pots And Sliders

The knob and slider are used to set whether to detect VRA and VRB S1 represents VRA, and S2 represents VRB. There are three states: "OFF", "AUTO", and "ON".

When "OFF" is selected, the positions of VRA and VRB are not detected upon power-on.

When "AUTO" is selected, it works automatically.

When "ON" is selected, it detects whether the VRA and VRB are in the initial

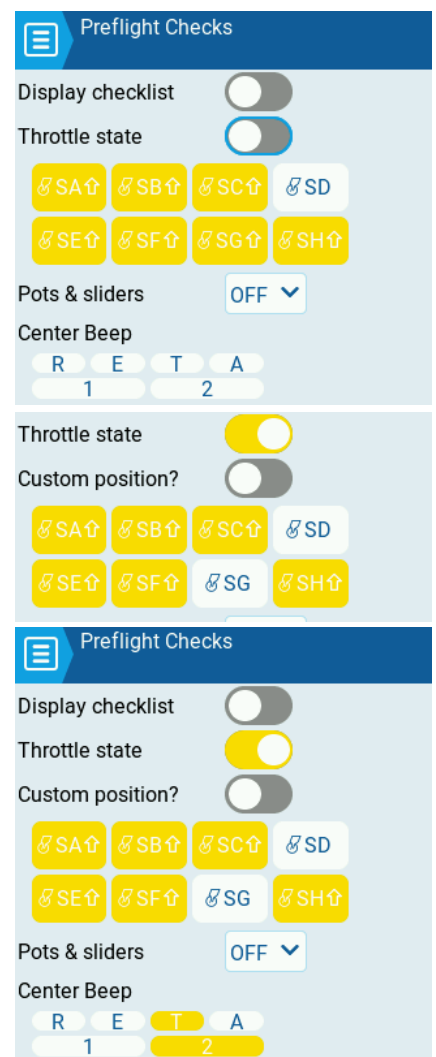

position upon power-on.

Center Beep

Set the stick midpoint detection of the channel. When the stick passes the midpoint, the transmitter will give a prompt through vibration. The yellow background indicates that the middle position of the channel will be detected.

7.3.12 Trims

With this function, you can set the step value and display mode of the trim.

If you click "Reset", all trims will return to the initial position.

Trim step

"Exponential" To modify the trim step to exponential adjustment.

"Extra Fine" To modify the trim step value to 1.

"Fine" To modify the trim step value to 2.

"Medium" To modify the trim step value to 5.

"Coarse" To modify the trim step value to 8.

Extended Trims

After the "Expanded trims" is selected, it will expand the trim range. The default trim can be adjusted to a maximum of 25%. After it is selected, a maximum of 100% can be adjusted.

Display Trims

"No" The trim amount is displayed in the main interface. The current trim value will not be displayed when the trim value is changed.

"Change" Display the current trim value when the trim value is changed.

"Yes" Always display the current trim value.

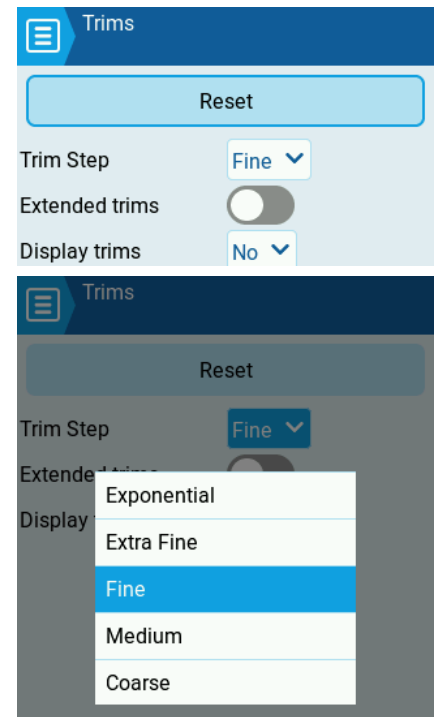

7.3.13 Throttle

Reverse

The throttle will be reversed after this option is selected. It is recommended to debug in the "Mixes" menu or output setup when the throttle reverse is set.

Source

Set the input source of the throttle. It can be set to transmitter control or channel, generally set to "Thr".

Trim Idle Only

(To be updated...)

Trim Switch

Select the trim button to adjust the throttle, the default is "Thr".

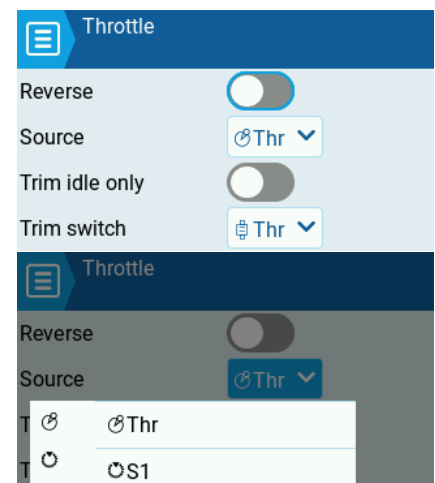

微信公众号



Bilibili



Website



Facebook

7.3.14 HELI Setup

(To be updated...)

7.3.15 Flight Modes

To cope with different flight conditions or special flight tasks, you need to set different flight modes, to achieve some precise movements, or fast rolls. Therefore, the stick rate and travel requirements vary with flight modes.

With this function, you can set the name of each mode, ON switch, trim values of different modes, and the entry and exit time in the switching transition of each flight mode, respectively. Up to 8 flight modes can be set.

Take FM1 mode as an example.

Name

To set the name of the current flight mode. The name contains up to 10 characters.

Switch

To set the switch to enable the current mode. It can be set to gear switch, trim switch, logic switch, etc.

For example, set the throttle trim button to toggle upwards as a switch, select "SB-", and toggle SWB in the middle position to enable the flight mode.

Fade in

(To be updated...)

Fade out

(To be updated...)

Trim

(To be updated...)

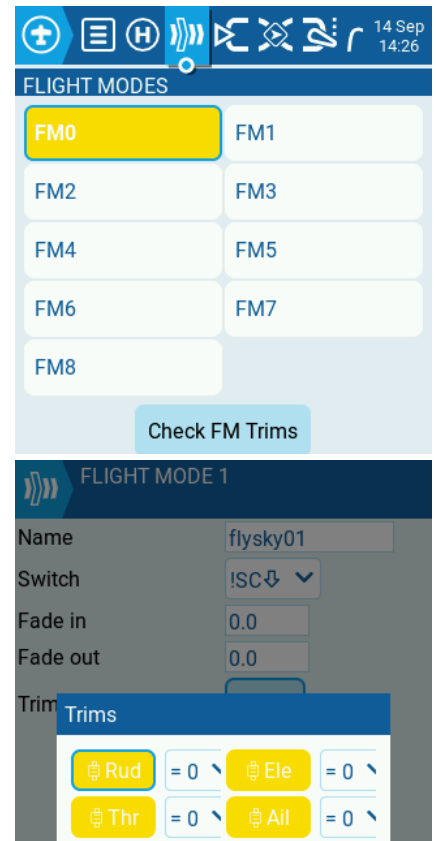

7.3.16 Inputs

It is used to assign serial number, name, switch, curve, trim, and offset for each input. The serial number in the input setup does not represent the actual output channel serial number. The parameters in the input setup are set for each input source stick, toggle switch, knob, trim, button, and logic switch. The parameters set for each input source may be brought into the mixer that references the input for the calculation.

By setup each input to be referenced, it is more convenient for the use by the mixes in future.

Input name

To set the name of the channel, with up to 4 characters.

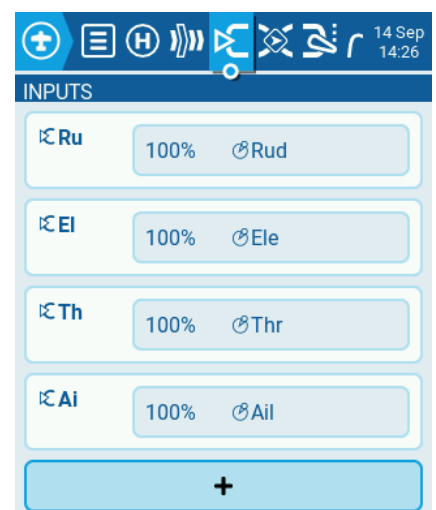

Line name

To set the name of the current default curve.

Source

It is used to set the input source. The source selection can be stick, knob, switch, button, trim, logic switch, etc.

Weight

Set the percentage of the input source. Adjust the rate output. The adjustable interval is between -100 and +100. When the value is less than 0, the input source will be reversed. The setup of the rate will affect the travel of the servo. The rate set in the mixes will have a superposition operation with the rate in the input setup, to prevent the output of the superposition operation from exceeding the maximum angle of the servo. The rate can be set in the input setup according to the travel of the servo to limit the maximum output of the servo.

It is recommended to set the outputs when the servo is reversed.

Offset

Adjust the offset (upward and downward) of the curve. It affects the high travel, low travel and the neutral travel.

Switch

Enable and disable this input source. The switch can be a physical control and a logical switch. By default, it is enabled. In this case, it is selected as "---"

Curve

Set different output curves for various input sources. Different curves will have different manipulation feels. Users can set the appropriate curve according to their operating needs.

In this function, there are four modes: "Diff", "Expo", "Func" and "Cstm". A variety of output curves can be selected under different curve modes.

"Diff" Adjust the one-side curve without changing the linearity of the curve, but changing the high and low travel of the curve.

"Expo" Adjust the linearity and ratio of the curve. Adjust the two-sided curve at the same time. The larger the value is, the smoother the front-end curve change is. The back-end changes quickly. When the value is negative, it is opposite.

"Func" In this mode, a variety of algorithmic curves are preset. Users seldom use these curves.

Take "Func"--"f<0" as an example. If the output source is < 0, the output = -100%. If the output source > 0, the output = 0.

The above curve setup is affected by the rate and offset. The output will change according to the different setups of the ratio and offset. You can check the curve changes in the display bar to set it during the actual operations.

"Cstm" Select the curve in Curve Setup.

The screenshot shows the 'INPUTS' configuration screen for 'fly1'. The top section shows a dropdown menu for 'Input name' with options: Ele, Thr, Ail, SA. The middle section shows settings for 'fly1': Line name (—), Source (S2), Weight (-50% GV), Offset (15% GV), Switch (—), and Curve (Expo 0% GV). Below this are three graphs showing different curve shapes: a linear curve (Expo -100% GV), an exponential curve (Expo 100% GV), and a step function curve (Func f<0). The bottom section shows a dropdown menu for 'Input name' with options: !CV7, !CV6, !CV5, !CV4.



微信公众号



Bilibili



Website



Facebook

Click the  icon to enter more setups.

"Side" The function is similar to Func. For example, if " $x > 0$ ", then the low-side input is all "0".

"Trim" Set the trim button to use for this input setup.

"Modes" Select the flight mode that is effective for this input setup.

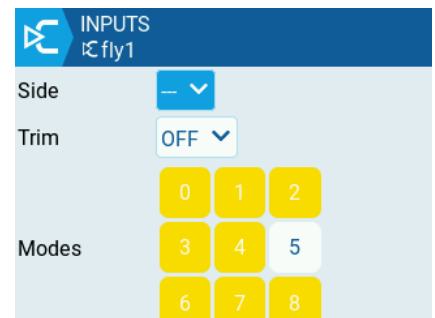

7.3.17 Mixes

The Mixes setup logic of EdgeTX is very flexible, that is, a variety of mixes input sources and output sources. There are three implementation modes: (1) a control → a channel; (2) a control → multiple channels; (3) multiple controls → a channel. Wherein mode (3) is mostly applied to the setup of delta-wing airplanes.

To deeply understand the EdgeTX's mixer function, the above controls can be considered as "Input setup - Input source". In the "Input setup" menu, each line can be superimposed with more lines. There is one input setup, with multiple input sources.

The figure shows the basic setup of delta-wing airplane for input setup and mixes setup.

To understand the relationship between input setup and mixes correctly, the operator should understand the relationship by considering the action that his model needs to achieve. For example, for a delta wing, aileron roll and pitch are the actions achieved by the two wings, and the two wings are controlled by the servo. Under normal circumstances, the two servos are connected to the receiver CH1 and CH2. CH1 and CH2 of the receiver do not mean that the actual output of CH1 and CH2, and you can understand as input source 1 and input source 2. In the input setup, set the input source of input 1 and input 2 to Aileron and Elevator respectively. For the manual operation in USA, the receiver CH1 corresponds to Aileron J1 stick, CH2 corresponds to Elevator J2 stick.

In the mixes setup, you can set which input sources are needed for each channel and the travel of the input sources according to the actions you need to achieve.

In the use of the EdgeTX's mixes, each mix should be set with the consideration of the action that the model needs to achieve. It is helpful to better understand and realize the logic principle of each mix.

The travel of each input source can be set in the mixes setup. The travel will have a superposition operation with the travel setup in the input setup. Therefore, pay special attention to the travel setup to prevent the travel from exceeding the limit of the servo in the debugging. Otherwise, the servo may be damaged.

Click "+" in the main interface to add a channel. You can also perform the channel setup.

On each main interface, you can perform the "Input setup" of the reference.

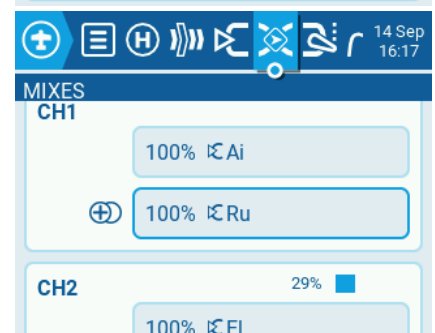
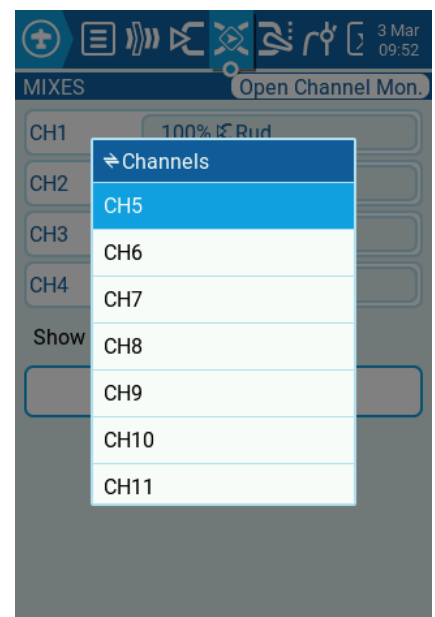

Edit

Set the selected input setup, such as name, effective flight mode, input source, curve, etc.

Insert Before

Add a new input setup before the selected entry.

Insert After

Add a new input setup after the selected entry. The main difference between the insertion before and after this entry is the "Multiplex".

Copy

Copy the selected input setup.

Move

Move the selected input setup.

Delete

Delete the selected input setup.

Select Edit to enter the setting interface.

"Name" It is used to set the mixes name. It is recommended to set the name of each mixer according to the model's action for better understanding and usage.

"Source" It is used to set the input source referenced by the mixes. The input source can directly refer to the input setup and various controls. The reference of the input setup as the input source can apply the parameters in the input setup to the mixer at the same time. However, the direct reference of a control does not necessarily cause the calling of the relevant setup of this control. It is recommended that the input source should reference the output setup to achieve more direct setup for each control.

"Weight" It is used to set the percentage of each input in the mixer and adjust the ratio output. The adjustment interval is from -100 to +100. When the value is less than 0, the input source will be reversed. This ratio will be superimposed with the ratio in the input setup.

"Offset" It is used to adjust the upward and downward offset of the curve, affecting the high travel, low travel, and neutral travel. The offset of the input setup and the mixes will be superimposed. In the debugging, take measures to prevent the superimposed travel from exceeding the maximum angle of the servo. Otherwise, the servo may be damaged.

"Switch" It is used to set a control to enable and disable the mixer. If there is no setup, "---" is displayed, indicating that the mixes is always effective.

"Curve" In the top display bar of this interface, you can check the current channel status.

Note: The usage is similar to the curve usage in the input setup.

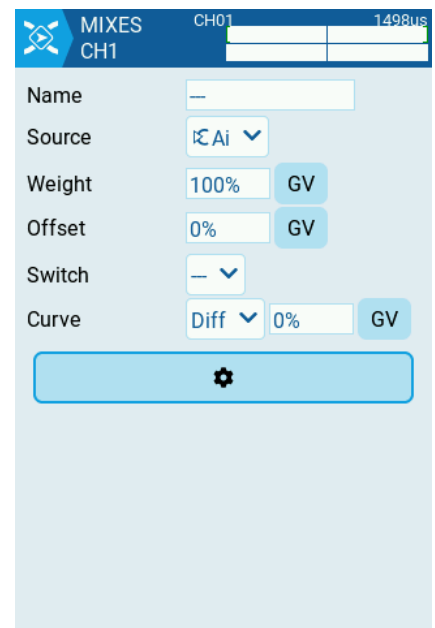
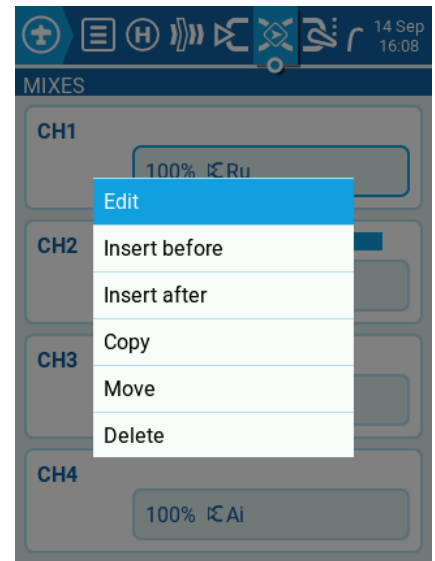

微信公众号



Bilibili



Website



Facebook

Click the  icon to enter more setups.

"Multiplex" It is used to control how to calculate the output between multiple input sources input setup when the mixes references multiple input sources. Three modes are available:

--Add: The channel values are output with a sum of multiple input sources.

--Multiply: [\(To be updated...\)](#)

--Replace: [\(To be updated...\)](#)

"Modes" This function allows you to set the flight mode applied to this curve. The yellow background indicates that the mode is applied, and the white background indicates that the mode is not applied. The applied mode will be available for query in the mixes interface.

"Trim" [\(To be updated...\)](#)

"Warning" Enable the warning tone of the mixes. By default, it is off. The highest value is "3". That is, after the mixes is enabled, the system will have a "beep" tone, indicating that the mixer has been enabled.

"Delay up" Implement the uplink delay function of the channel. The channel delay is a form of step. For example, if you set that the uplink delay is 2s and the stick output is 50%, the channel delay is from 0% to 50% in 2 seconds. Uplink refers to the travel interval of -100% → 0 → +100%.

If the reversal is set, the output of uplink delay will also be reversed. The delay direction of uplink delay is not affected by the reverse setup. In the channel view interface, you can better distinguish them according to "Channel output" and "Mixe output".

After the uplink or downlink delay function is enabled, you can view the different icons on the channel status bar in the mixer main interface.

"Delay down" Implement the downlink delay function of the channel. The downlink refers to the travel interval of +100% → 0 → -100%.

"Slow up" Implement the uplink slow motion delay function of the channel. The channel delay mode is a form of slow motion. For example, if you set the 2s uplink slow motion and the stick output is 50%, the channel slowly increases from 0% to 50% in 2 seconds. Others are the same as the uplink delay.

"Slow down" Implement the downlink slow motion delay function of the channel.

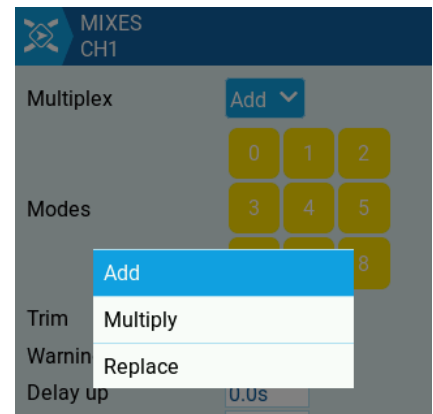

7.3.18 Outputs

Add All Trims to Subtrims

[\(To be updated...\)](#)

Extended Limits

[\(To be updated...\)](#)

Click any channel. Four options are displayed.

Edit

Set relevant parameters for the selected channel, such as channel name, midpoint, reverse, etc.

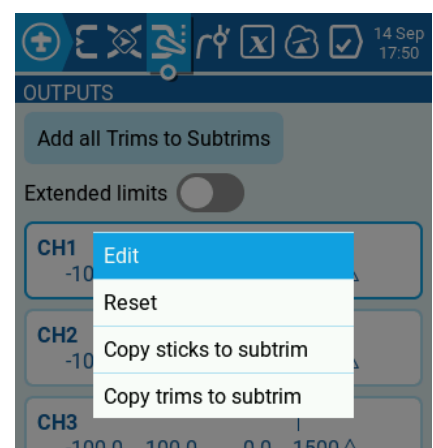

"Name" It is used to name the current channel, with containing up to 6 characters.

"Subtrim" It is used to set the midpoint of the current channel. The maximum value is +100 and the minimum value is -100.

When the mixer of the channel references one or more input setups, the value of the midpoint will be involved in the calculation of different curves and different superposition methods.

"Min" It is used to set the minimum output value of the channel. This setup will limit the final channel output value after various curves and superimpositions are set.

"Max" It is used to set the maximum output value of the channel. This setup will limit the final channel output value after various curves and superimpositions are set.

"Inverted" It is used to set the output reversal of the channel.

"Curve" The selected curve is the used curve for this channel.

"PPM Center" Set the midpoint of the channel. This value will be superimposed with the value of the trim button.

"Subtrim Mode" (To be updated...)

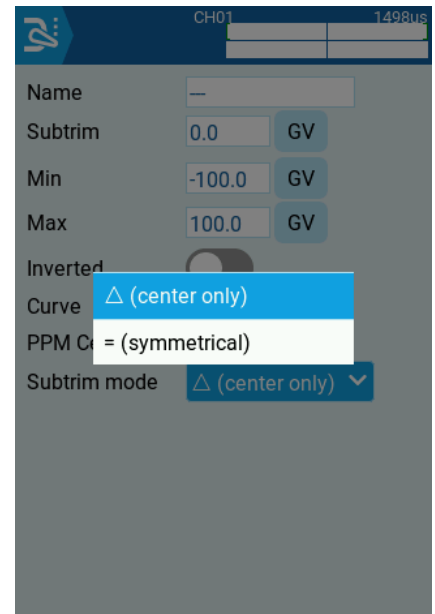

Reset

Reset the selected channel to the system default parameters.

Copy Sticks to Subtrim

(To be updated...)

Copy Trims to Subtrim

(To be updated...)

7.3.19 Curves

Up to 32 different curves can be set in the EdgeTX, including "Input setup", "Mixes", "Input setup", etc.

Click any curve and click "Edit" to set the curve.

"Name" To set the name of the curve.

"Type" You can set two types: "Standard" and "Custom".

"Smooth" When the smooth effect is enabled, the turning point of the curve will be smooth.

In the "CURVES", you can set up to 17 points. The value of each point can be set individually. When the set points exceed the maximum number of points that can be displayed on the screen, slide the screen frame to switch.

After the curve is set, the shape of the curve will be displayed in the main interface of "CURVES".

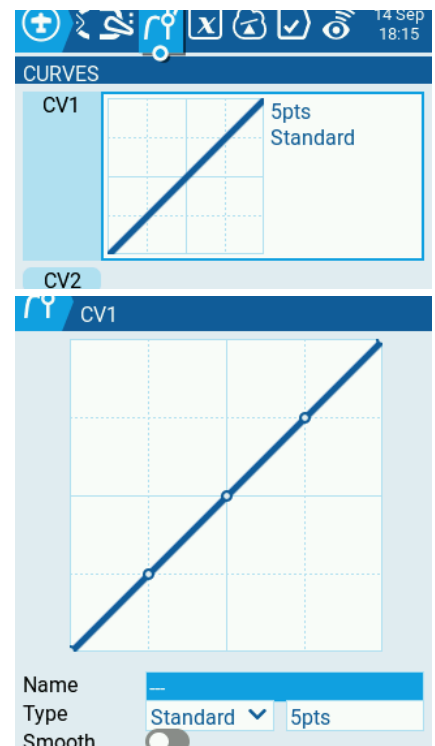

微信公众号



Bilibili



Website



Facebook

7.3.20 Global Variables

(To be updated...)

7.3.21 Logical Switches

The EdgeTX logic switch is a kind of programmable virtual switch, unlike the usual logic switch. The input sources selected are for various physical control switches. The input source of the EdgeTX logic switch can be physical control switches, telemetry values height, temperature, current, voltage, speed, RSSI, etc., other logic switches, input values of controls, global variables, timers, etc.

Operation symbol types of logical switches:

Type 1: Variables And Constants

There are 6 options: $a=x$; $a\sim x$; $a>x$; $a<x$; $|a|>x$; $|a|<x$;

"a" is the judgment input source of V1, and "X" is a set constant.

Example: Select "a>x", set V1 input source to throttle stick, $x=50$. That is, when the throttle stick output is greater than 50, the logic switch will be triggered.

Type 2: Logical Operations

"AND" AND operation. V1 and V2 input sources are in the AND relationship. The logical switch is enabled if both outputs are true.

Example: Select V1 input source "SD lowest" and V2 input source "SG highest". When SD and SG are in the lowest and highest position respectively, the logical switch is enabled.

"OR" OR operation.

"XOR" XOR operation.

"Edge" (To be updated...)

Type 3: Variables And Variables

"a=b" The logical switch is enabled when the value of V1 input source is equal to V2 input source.

"a>b" The logical switch is enabled when the value of V1 input source is greater than V2 input source.

"a<b" The logical switch is enabled when the value of V1 input source is less than V2 input source.

Type 4:

(To be updated...)

Other options are as follows:

"AND" Used to set the general switch of the logic switch. By default, it is set to "---", indicating that the general switch is ON. You can also set other input sources as the switch.

"Duration" Used to set the effective time that the logic switch is ON. The maximum value is 25s.

"Delay" Used to set the delay time for triggering the logic switch to turn on. The maximum value is 25s.

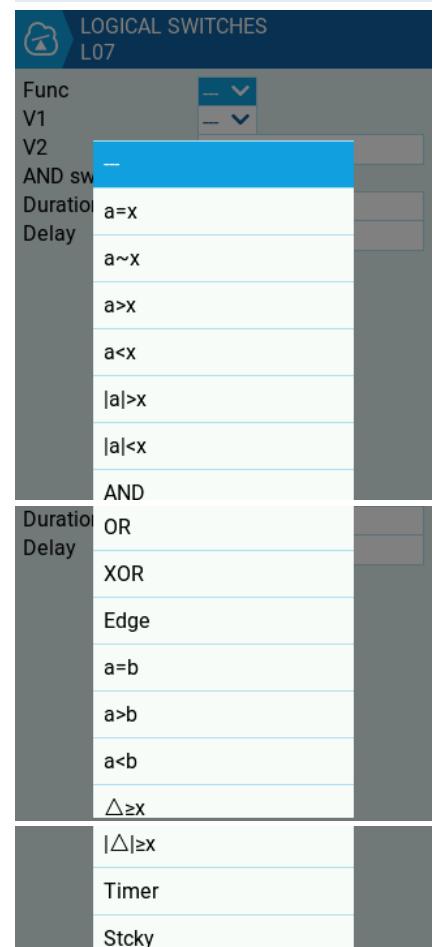
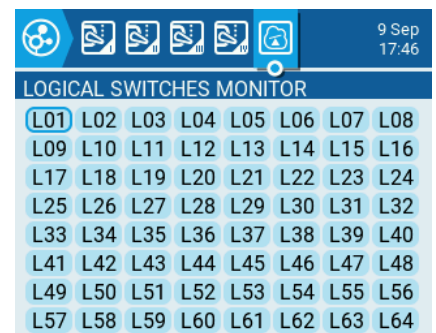
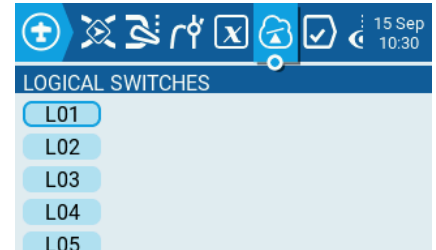

7.3.22 Special Functions

This system can implement some special functions, such as locking channel value, reset, volume, playing audio files, etc. More complex functions can be implemented after some lua scripts are used.

EdgeTX provides 64 kinds of special function setup for each model. The effective switch of special functions can also be a variety of input sources, similar to input setup, and mixer input setup. You may also choose a logic switch as the input setup.

Switch

It is the switch used to assign special functions to take effect.

Function

Used to trigger the corresponding functions after the special function switch is enabled and effective. Some of the functions are listed below:

"Override" Make the specified channel value output a fixed value.

"Trainer" [\(To be updated...\)](#)

"Inst. Trim" [\(To be updated...\)](#)

"Reset" Reset the specified timer or transfer-back parameter.

"Set" [\(To be updated...\)](#)

"Adjust" [\(To be updated...\)](#)

"Volume" Used to adjust the volume of the transmitter.

"SetFailsafe" [\(To be updated...\)](#)

"Play Sound" Play the specified tone file after triggering the special function switch to take effect.

"Play Track" Play the specified track in SD card after triggering the special function switch to take effect.

"Play Value" Play the current output audio value of the specified channel.

"Lua Script" [\(To be updated...\)](#)

"Vario" [\(To be updated...\)](#)

"SD Logs" [\(To be updated...\)](#)

"Screenshot" Shoot the current screen and store it to SD card under the SCREENSHOTS folder.

"RacingMode" [\(To be updated...\)](#)

"No Touch" Touch screen is disabled after the special function is triggered.

Value

Select the input source, audio file, and lock output value for the value playback.

Cycle

Set the number of cycles. "1x"; "1x" -- trigger only once; "1s" -- trigger every 1s.

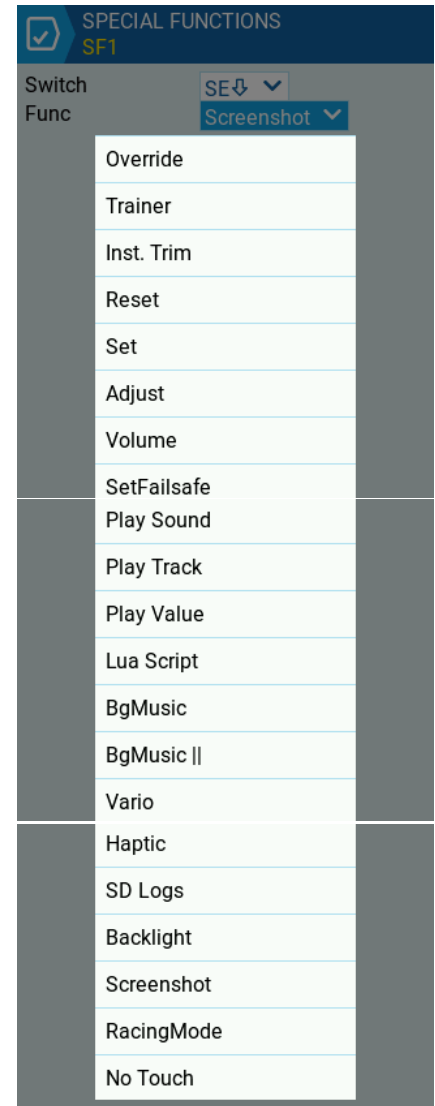

微信公众号



Bilibili



Website



Facebook

Reset

Select the function to be reset, such as "Timer 1", "Timer 2", etc.

Enable

Set the special function to take effect.

7.3.23 Telemetry

Set the relevant functions for RSSI signal strength, sensor telemetry data and altitude change rate. The transfer-back function of the EdgeTX is very powerful. It can connect multiple sensors of the same type. This function can be used to edit the functions of the sensor. In EdgeTX, all telemetry values can be used as a single sensor data for editing related functions.

RSSI

"Low alarm" and "Critical alarm" Set the alarm threshold value of the signal strength.

"Disable telemetry alarm" Set whether to enable RSSI signal strength alarm.

Sensor

Display the current sensor number, the name of the transfer-back telemetry data, detection digit, and ID.

The following is the sensor telemetry data in the connection to the Flysky receiver:

"A1" Display the current input operating voltage of the receiver.

"RSSI" Display the current signal strength value.

"Tmp1" Display the current temperature sensor value.

"Alt" Display the current altitude value of the barometric pressure sensor.

"Pres" Display the current barometric pressure value of the barometric pressure sensor.

Click the sensor value and select "Edit" to edit the function of the sensor.

"Name" (To be updated...)

"Type" (To be updated...)

"Custom" (To be updated...)

"ID" (To be updated...)

"Opration" (To be updated...)

"Unit" Select the appropriate calculation unit for the sensors. For example, V voltage, A current, m length or height, mah battery capacity, etc.

"Accuracy" "0.--": Display the accuracy to a single digit; "0.0-" shows the accuracy to one decimal point; "0.00" shows the accuracy to two decimal points.

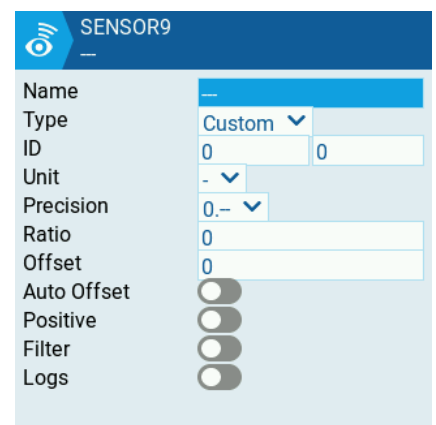
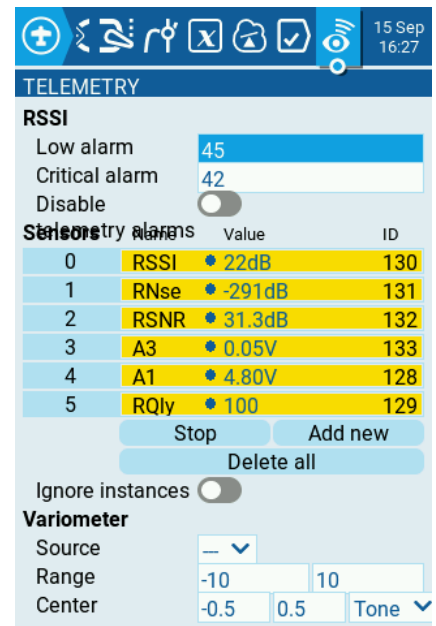

"Formula" After selecting the type of "Operation", you can select different calculation formulas to calculate the detection values of multiple sensors.

"Add" Calculate the sum of the selected multiple detection values.

"Average" The average of the selected multiple detection values is calculated.

"Minimum" The minimum value of the selected multiple detection values is displayed.

"Maximum" The maximum value of the selected multiple detection values is displayed.

"Multiply" Multiplication of the selected multiple detection values.

"Totalize" (To be updated...)

"Cell" (To be updated...)

"Consumpt" (To be updated...)

"Distance" (To be updated...)

"Input source 1" Select the transfer-back data for calculation and display.

"Input source 2" Select the transfer-back data for calculation and display. Up to 4 input sources are allowed.

"Auto offset value" (To be updated...)

"Positive" Display all detected negative values as positive values.

"Wave filtering" (To be updated...)

"Hold" (To be updated...)

"Logs" Enable the record function. The detection data will be recorded on the SD card. The logging needs to be activated by the special function.

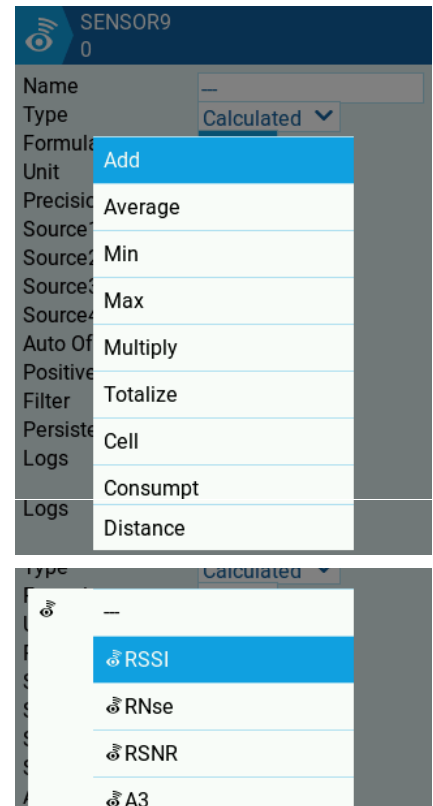

7.4 Radio Settings

7.4.1 Tools

(To be updated...)

7.4.2 SD-HC Card

Used to browse SD card directory. It can perform the functions of viewing text, executing lua files, playing audio, copying, renaming and deleting SD card files.

"FIRMWARE" Transmitter firmware upgrade directory. The downloaded transmitter firmware is in this folder for upgrade.

"IMAGES" Model picture folder. Images are in the JPEG format in RGB

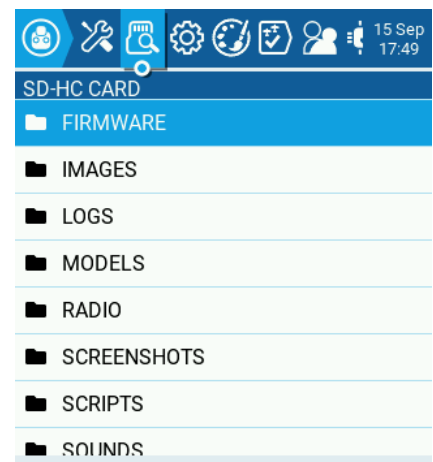

微信公众号



Bilibili



Website



Facebook

color.

"LOGS" Log folder.

"MODELS" This folder contains model information.

"RADIO" (To be updated...)

"SCENESHOTS" The screenshot images will be saved under this path when the screenshot function is enabled.

"SCRIPTS" Lua script folder.

"SOUNDS" Voice folder. The recommended audio format: audio sampling rate 8 kHz, 16 kHz or 32 kHz wav audio with bit depth 8 or 16.

7.4.3 Radio Setup

Date & Time

Display the current system date and time. The values can be modified. By default, the date and time are displayed in the upper left corner of the main interface.

Sound

Set the trigger conditions, volume, tone, and broadcast duration of each sound in the system.

"Mode" Set the trigger conditions for the effective sound.

--"Quiet" All sounds are turned off.

--"Alarm" Only the warning tone is allowed.

--"Nokey" Disable the touch tone only.

--"All" Enable all prompt tones.

"Volume" Set the primary volume level change the prompt volume, voice volume and background voice volume at the same time.

"Beep volume" Set the prompt voice volume.

"Beep length" Set the prompt voice duration.

"Beep pitch" Set the prompt pitch. The range is 0-300 Hz.

"Wav volume" Set the voice volume.

"Background volume" Set the background music volume.

Variometer

Use the receiver with the transfer-back function, with GPS or barometer sensor information. Click "Discover new" on the "Model Settings" - "TELEMETRY" page. Select "Alt" or other altitude information as the input source for the altitude change rate. Calibrate the range to use the altitude change rate function correctly.

"Volume" Set the volume level of the altitude change rate.

"Pitch zero" Range: 300 Hz-1100 Hz.

"Pitch Max" Range: 900 Hz-2500 Hz.

"Repeat zero" 200 ms-1000 ms

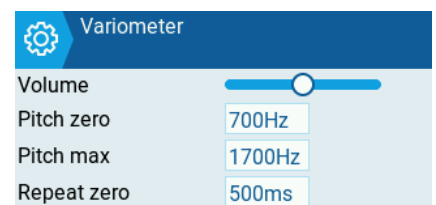
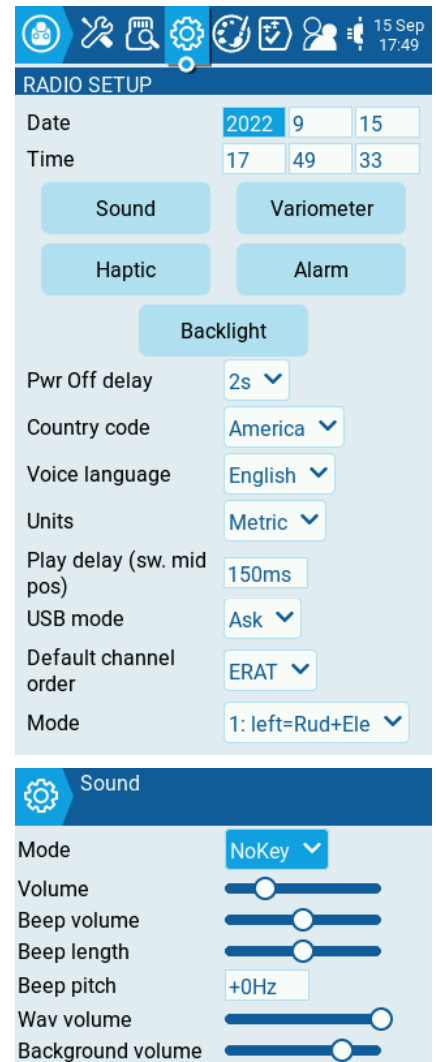

Haptic

"Mode"

- "Quiet" All vibrations are off.
- "Alarm" Only the warning vibration is available.
- "Nokey" Disable the touch vibration only.
- "All" Enable all vibrations.

"Length" Set a single vibration feedback duration.

"Strength" Set the vibration strength.

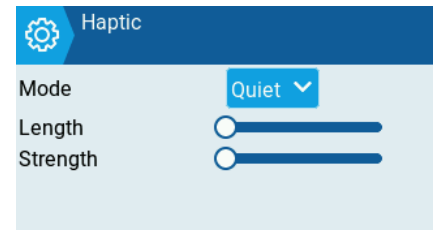

Alarm

"Battery low" Set the low voltage alarm value. The range is 3.0v-12v.

"Inactivity" If the transmitter is not operated for a long period, the system gives an alarm. The range is 0-250 minutes. When it is set to 0, the alarm is disabled.

"Sound off" If the Sound off is selected, the alarm sound is disabled.

"Shutdown" Check whether the transmitter is connected to an aircraft before the transmitter is powered off. The prerequisite is that the aircraft is enabled with the transfer-back function to correctly transfer back the RSSI.

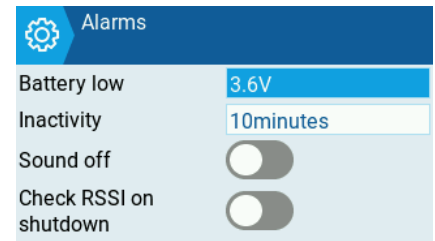

Backlight

To set the backlight parameters of the screen.

Power Off Delay

Set the time to wait for the transmitter to shut down after pressing and holding the shutdown button on both sides. The range is 0-4s.

Country Code

It needs to match the geographic location to keep the radio frequency transmission parameters to comply with the regulatory requirements.

Voice Language

Select the language for broadcasting. This list contains all supported languages. Ensure that the voice package for the language is loaded onto the SD card located in a subfolder of the SOUNDS directory.

Units

Select the metric or imperial unit for the telemetry value.

Play Delay(SW. mid pos)

Delayed broadcast range: -150 ms-850 ms.



微信公众号



Bilibili



Website



Facebook

USB Mode

Set the computer-transmitter recognition mode after the connection via the USB cable.

- "Ask" After the connection via USB, a pop-up window is displayed, indicating to select the joystick, U disk or serial mode.
- "Joystick" Connect to the simulator.
- "Storage" Read and modify files in the SD card.
- "Serial" Used to upgrade the firmware.

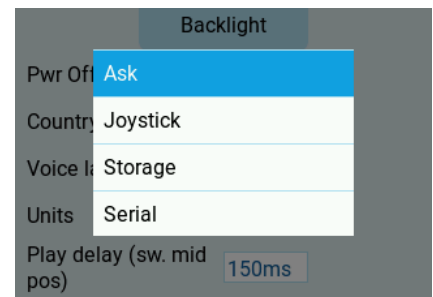

Default Channel Order

Set the stick mode of each model. If it is selected as AETR, the channel is CH1-Ail, CH2-Ele, CH3-Thr, or CH4-Rud.

Mode

Set the channel assignment of the left and right sticks.

- "1: left=Rud+Ele" It indicates that the left stick corresponds to yaw and pitch, respectively.
- "2: left=Rud+Thr" It indicates that the left stick corresponds to yaw and throttle, respectively.
- "3: left=Ail+Ele" It indicates the left stick corresponds to aileron roll and pitch, respectively.
- "4: left=Ail+Thr" It indicates the left stick corresponds to aileron roll and throttle, respectively.

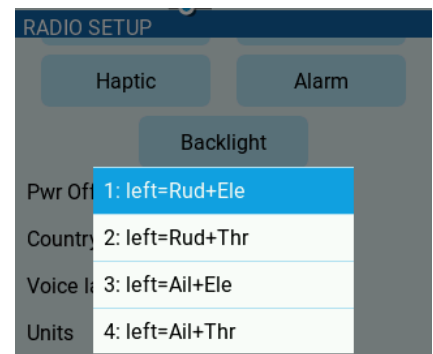

7.4.4 Themes

(To be updated...)

7.4.5 Global Functions

Global Functions GF1 to GF64 are allowed to customize functions that apply to all models, such as specific switches, potentiometers, sliders, etc. Thus, it is unnecessary to set the same function on "Model Settings" in the "SPECIAL FUNCTIONS" page. For specific setup, see the "SPECIAL FUNCTIONS".

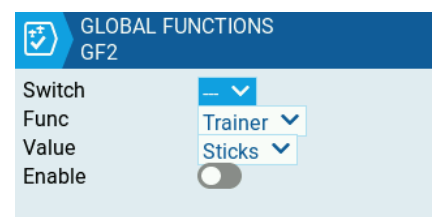

7.4.6 Trainer

It is used to select the trainer control or student control for the output computation mode after the trainer mode is enabled. Assign the trainer control output channel corresponding to the student control input channel, to calibrate the stick deviation of both.

There are three options for the output computation mode: "OFF", "=(Replace)" and "+(Add)".



"=(Replace)" The student control command completely replaces the trainer control command in this channel.

"+(Add)" The trainer control command and the student control commands are added together in this channel.

"OFF" The channel will not be controlled by student control.

Calibration

It is used to calibrate the stick deviation between the trainer control and the student control. By using this function, you can put all the sticks of the trainer control and the student control in the middle position. To complete this, click the "Calibrate" button.

1. The process of using the trainer function: "Model Settings" -- "Trainer" -- "Mode": Select the appropriate connection mode for trainer control and student control.
2. "Model Settings" -- "Special function": Enable the trainer function and assign the trainer function switch.
3. "Radio Settings"--"Trainer": Set the relevant input and output parameters for trainer control and student control.

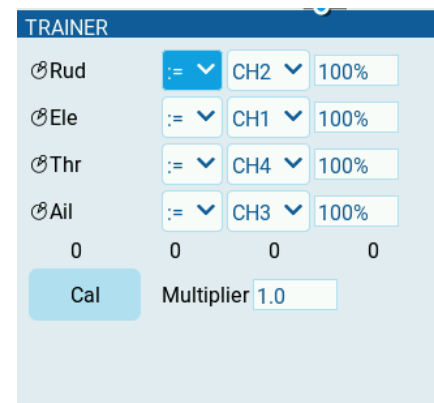

7.4.7 Hardware

Voltage

"Battery meter range" Set the voltage test range of the transmitter battery. The default value is 3.5V-4.2V.

"Battery calibration" Calibrate the voltage detection value of the transmitter battery. The detection value of the transmitter may differ from the battery voltage. You can calibrate it by using this function.

"Check RTC voltage" Set whether to enable the detection of time driven battery voltage.

"ADC filter" [\(To be updated...\)](#)

Internal RF

"Mode" Select whether to enable the internal RF in this function. When you set it to "OFF", the "Internal RF" function is disabled.

External RF

"Sample Mode" [\(To be updated...\)](#)

Serial Port

"USB-VCP" [\(To be updated...\)](#)

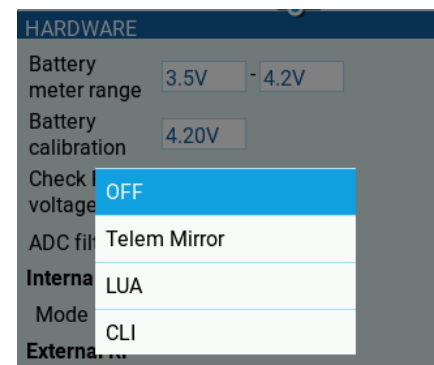
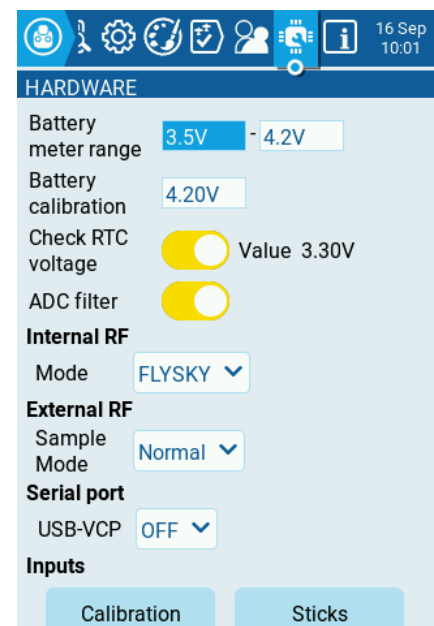

微信公众号



Bilibili



Website



Facebook

Inputs

"Calibration" You can calibrate the travel of the stick and knob. After the transmitter is used for a period of time, if there is drift or deviation of the stick or knob, you can calibrate it by this function. Refer to the pictures below for the steps of calibration.

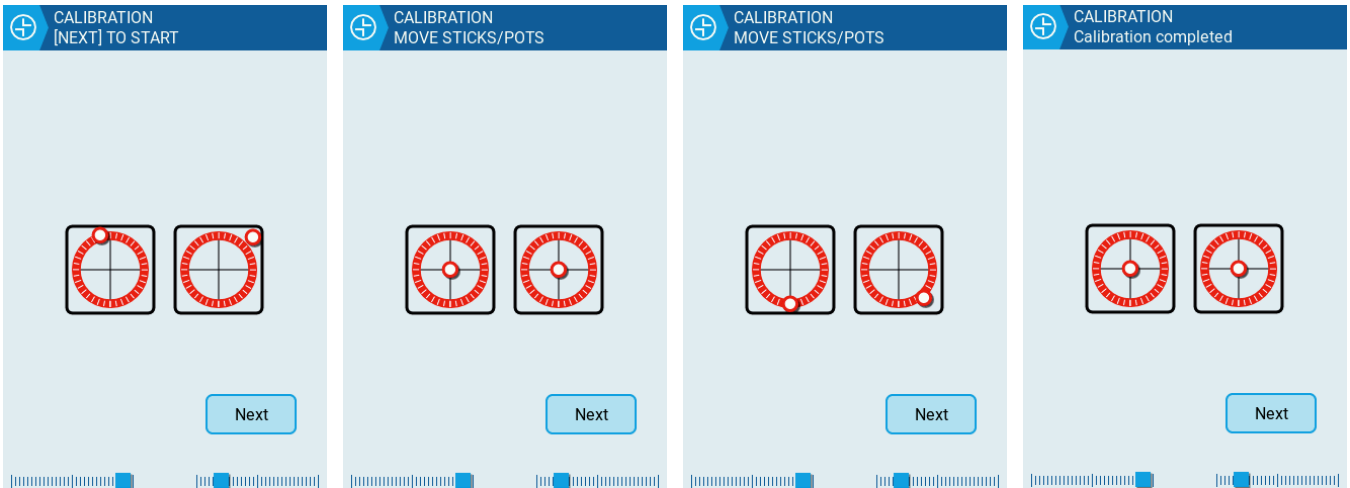

"Sticks" To modify the default name of CH1-CH4, and dead zone value of the stick. The maximum value is 128.

"Pots" To modify the default names of S1 VRA and S2 VRB, as well as the knob setup type.

"Switches" To modify the default name of each switch, and set the switch types such as two-way switch, three-way switch, and kickback switch.

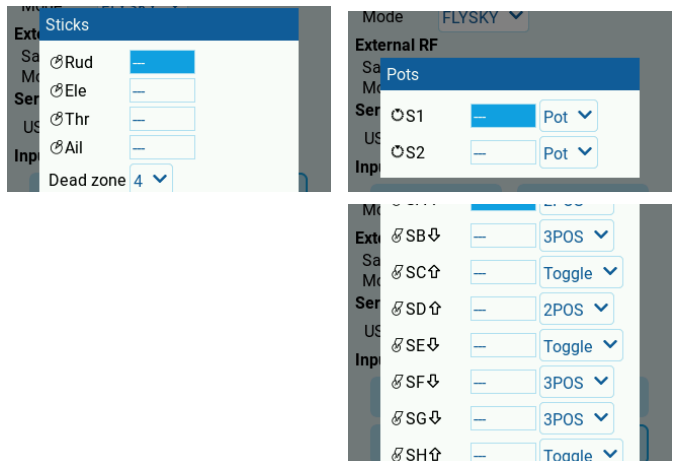

Debug

(To be updated...)

7.4.8 Version

Display information about the current firmware version, including firmware number, firmware update time, supported wireless protocols, etc.

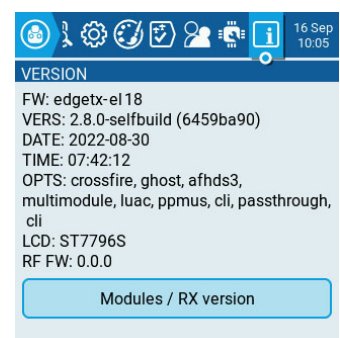

7.5 Screen Settings

With this function, you can select the display and layout parameters of the "Top bar" widget and "Main view" widget in the main interface.

In the Main View menu, click the layout box to select different layouts, such as "1+2", "1+3", "2+2", "2x2", etc. Users can choose different layouts according to their needs.

In the Main View of EdgeTX, you can set multiple interfaces as required by clicking "+" in the top box. After the setting is completed, you can switch to other interfaces by sliding the screen in the main interface. You can set up to three sub-interfaces.

Click the "Set" widget to enter the setup interface. Click on a layout box. A pop-up window is displayed, indicating to select a widget. That is, you can select different widgets, such as "Models current model", "Outputs current output of each channel", "Timer", etc.

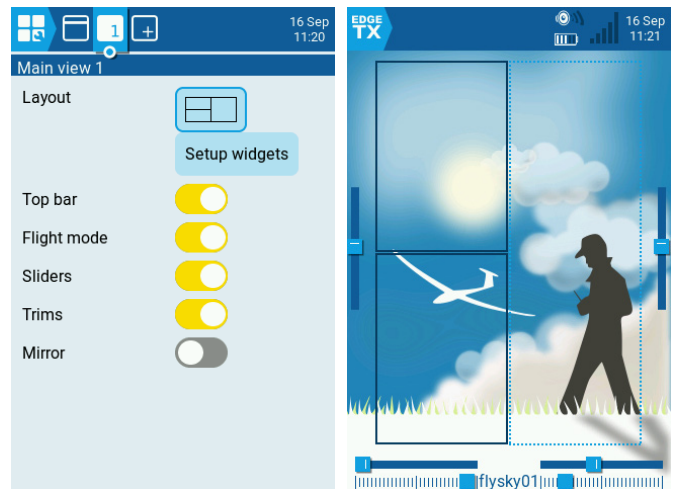

Top Bar

Select whether to enable the top bar display in the main interface.

Flight Mode

Select whether the flight mode can be displayed.

Slider

Select whether the main interface displays the position of the slider VRA/VRB.

Trim

Select whether the main interface displays the trim position.

Mirroring

(To be updated...)

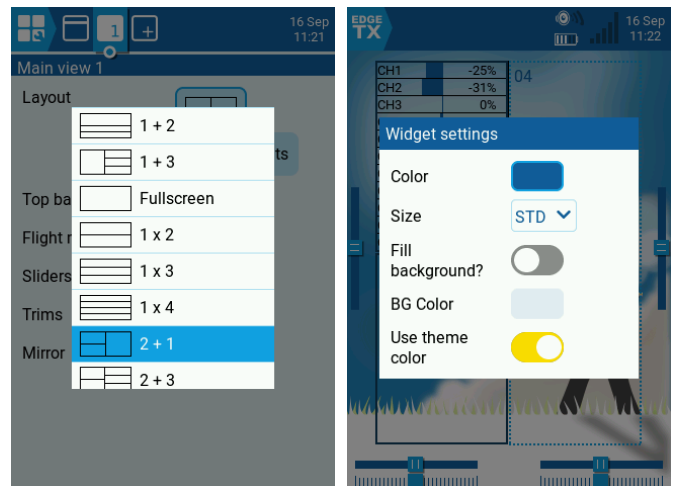

7.6 Reset

You can reset the flight record, timer and transfer-back parameters. For the reset function, you can assign a switch as a reset switch by choosing "Model Settings"--"Special Function" or "Global Function".

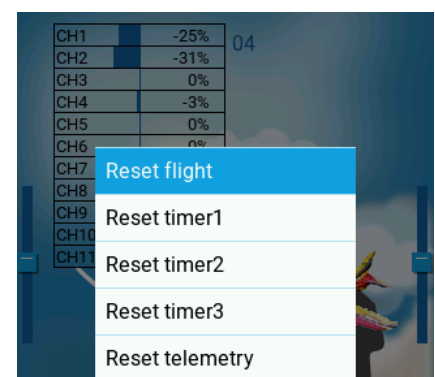

微信公众号



Bilibili



Website



Facebook

7.7 Statistics

(To be updated...)

7.8 About EdgeTX

To view EdgeTX related information by scanning the code in this function.



8. Product Specifications

This section describes the specifications for Elysium EL18 transmitter.

8.1 Transmitter Specifications

Product Model	EL18
Compatible Receivers	Classic version receivers, such as FTr10 or FTr16s, etc. Enhanced version receivers, such as FTr8B, FTr12B or Tmr, etc.
Compatible Models	Racing drones, fixed-wing aircraft, gliders or multicopters, etc.
Number of Channels	18-channel is for Internal RF, and 32-channel is for External RF.
RF	2.4 GHz ISM
2.4GHz Protocol	AFHDS 3
Maximum Power	< 20dBm (e.i.r.p.) (EU)
Antenna	Two antennas, one is a built-in antenna, the other is external rotatable antenna.
Input Power	2* 18650 Li-Ion battery
Working Current	400mA/4.2V
Data Output	Type-C USB
Charging Port	Type-C USB
Resolution	4096
Screen	320*480 resolution IPS color touch-screen
Distance	> 3500m (Air distance without interference)
Online Update	Yes
Temperature Range	-10°C ~ +60°C
Humidity Range	20% ~ 95%
Dimensions	205*183.7*82.9mm
Weight	726g
Certifications	CE, FCC ID: 2A2UNEL1800, UKCA



微信公众号



Bilibili



Website



Facebook

9. Package Contents

The accessories included are different in different versions, please consult your dealer for details.



10. Certifications

10.1 DoC

Hereby, [Flysky Technology co., Ltd] declares that the Radio Equipment [Elysium EL18] is in compliance with RED 2014/53/EU.

The full text of the EU DoC is available at the following internet address:

10.2 CE Warning

The antenna(s) used for this transmitter must be installed to provide a separation distance of at least 20 cm from all persons and must not be co-located or operating in conjunction with any other transmitter. End-users and installers must be provided with antenna installation instructions and transmitter operating conditions for satisfying RF exposure compliance.

10.3 FCC Statement

This equipment has been tested and found to comply with the limits for a Class B digital device pursuant to part 15 of the FCC rules. These limits are designed to provide reasonable protection against harmful interference in a residential installation. This equipment generates, uses and can radiate radio frequency energy and, if not installed and used in accordance with the instructions, may cause harmful interference to radio communications. However, there is no guarantee that interference will not occur in a particular installation. If this equipment does cause harmful interference to radio or television reception, which can be determined by turning the equipment off and on, the user is encouraged to try to correct the interference by one or more of the following measures:

- Reorient or relocate the receiving antenna.
- Increase the separation between the equipment and receiver.
- Connect the equipment into an outlet on a circuit different from that to which the receiver is connected.
- Consult the dealer or an experienced radio/TV technician for help.

To assure continued compliance, any changes or modifications not expressly approved by the party responsible for compliance could void the user's authority to operate this equipment. (Example use only shielded interface cables when connecting to computer or peripheral devices).

This equipment complies with Part 15 of the FCC Rules. Operation is subject to the following two conditions:

- (1) This device may not cause harmful interference.
- (2) This device must accept any interference received, including interference that may cause undesired operation.

Caution!

The manufacturer is not responsible for any radio or TV interference caused by unauthorized modifications to this equipment. Such modifications could void the user authority to operate the equipment.

1. Move all your channels to the desired position.
2. Select [All channels] and then [Yes] in the confirmation box.



微信公众号



Bilibili



Website



Facebook

10.4 Environmentally friendly disposal

Old electrical appliances must not be disposed of together with the residual waste, but have to be disposed of separately. The disposal at the communal collecting point via private persons is for free. The owner of old appliances is responsible to bring the appliances to these collecting points or to similar collection points. With this little personal effort, you contribute to recycle valuable raw materials and the treatment of toxic substances.



CAUTION

RISK OF EXPLOSION IF BATTERY IS REPLACED BY AN INCORRECT TYPE.
DISPOSE OF USED BATTERIES ACCORDING TO THE INSTRUCTIONS

10.5 UKCA Compliance Statement

Satisfies all the technical regulations applicable to the product within the scope of UK Radio Equipment Regulations (SI 2017/1206); UK Electrical Equipment (Safety) Regulations (SI 2016/1101); and UK Electromagnetic Compatibility Regulations (SI 2016/1091).





<http://www.flysky-cn.com>

Copyright ©2022 Flysky Technology co., Ltd

Publication Date:2022-11-15



微信公众号



Bilibili



Website



Facebook



CE, FCC ID: 2A2UNEL1800

Manufacturer: ShenZhen FLYSKY Technology Co., Ltd

Address: 16F, Huafeng Building, 6006 Shennan Road, Futian District, Shenzhen, Guangdong province, China