

Noble NB4

USER MANUAL

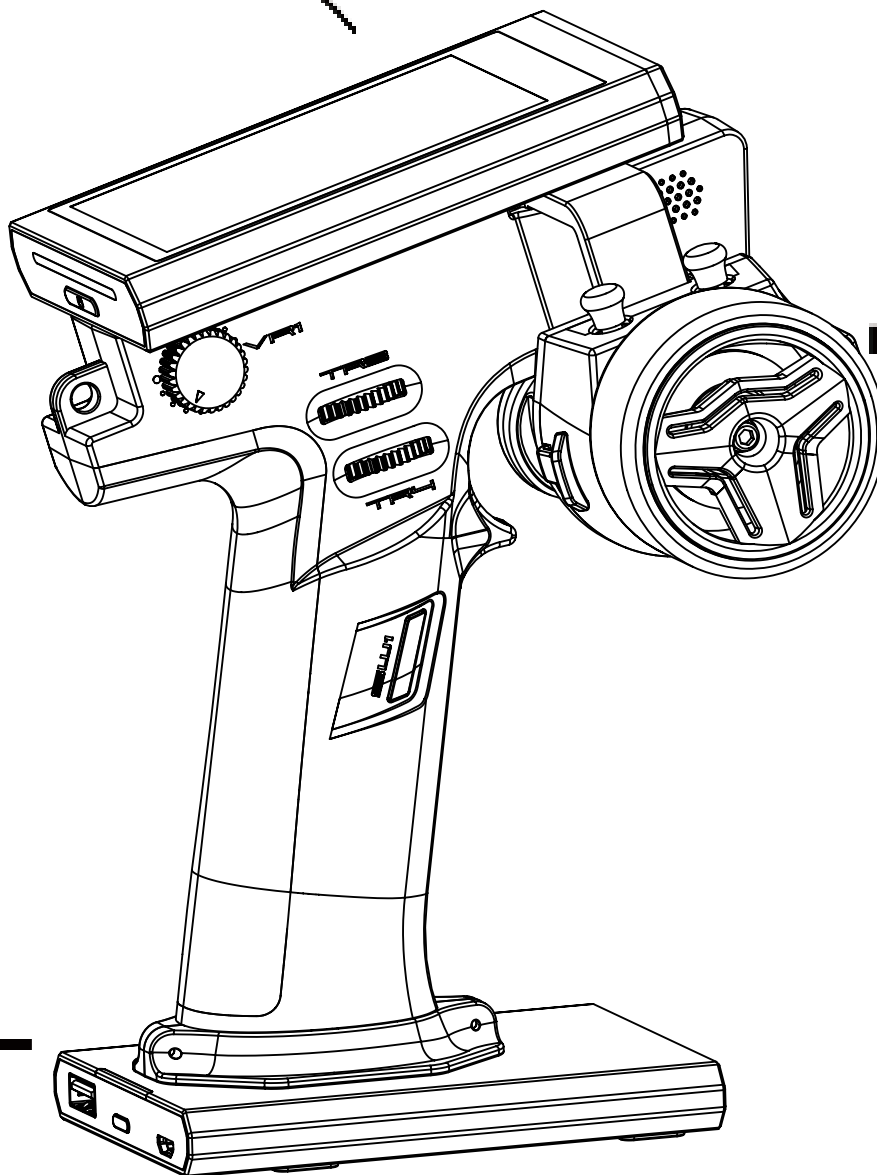

FLYSKY

Touching Infinity

Copyright ©2018 Flysky Technology co., Ltd



WARNING:
This product is only for 15 years
old or above

2.4GHz
AFHDS 3



Thank you for purchasing our product, an ideal radio system for beginners or experienced users.

In order to ensure your safety, and the safety of others, read this manual carefully before using this product. If you encounter any problem during use, refer to this manual first. If the problems persists, contact your local dealer or visit our service and support website:

www.flysky-cn.com

1. Safety	1
1.1 Safety Symbols	1
1.2 Safety Guide	1
2. Introduction	2
2.1 System Features	2
2.2 Transmitter Overview	3
2.3 Receiver Overview	6
2.3.1 Status Indicator	6
3 Getting Started	6
3.1 Transmitter Battery Installation	7
4. Operation Instructions	8
4.1 Power On	8
4.2 Binding	8
4.3 Transmitter LED Indicator	8
4.4 Power Off	8
5. System Interface	9
6. Function Settings	10
6.1 Reverse	10
6.2 End Points	10
6.3 Subtrim	10
6.4 Steering Exponential	11
6.5 Steering Speed	11
6.6 Steering Mix	11
6.7 Throttle Neutral	12
6.8 Throttle Exponential	12
6.9 Throttle Curve	12
6.10 A.B.S.	13
6.11 Throttle Speed	14
6.12 Throttle Middle	14
6.13 Throttle Idle Up	15
6.14 Engine Cut	15
6.15 Boat Mode	16
6.16 Brake Mixing	16
6.17 Mixes	16
6.18 Display Servos	17
6.19 Race Timers	17
6.20 Buttons Assign	17
6.21 Models	18
7. RX Setup	19
7.1 Bind With A Receiver	19
7.2 Failsafe	19
8. System	20
8.1 Backlight Timeout	20
8.2 Bind With A Receiver	20
8.3 System Sound	20

8.4 Vibration20

8.5 LED Light.....21

8.6 Language21

8.7 Auto Power Off21

8.8 Radio Frequency Setup.....21

8.9 Stick Calibration.....21

8.10 Firmware Update.....22

8.11 Factory Reset.....22

8.12 About Noble.....22

9. Product Specifications.....23

10. Package Contents.....24

11.Certification.....25

11.1 DoC Declaration25

11.2 CE Warning.....25



11.3 Enviromentally Friendly Disposal.....25

11.4 Appendix 1 FCC Statement.....26

1. Safety

1.1 Safety Symbols

Pay close attention to the following symbols and their meanings. Failure to follow these warnings could cause damage, injury or death.

 Danger	• Not following these instructions may lead to serious injuries or death.
 Warning	• Not following these instructions may lead to major injuries.
 Attention	• Not following these instructions may lead to minor injuries.

1.2 Safety Guide



Prohibited



Mandatory



- **Do not use the product at night or in bad weather like rain or thunderstorm. It can cause erratic operation or loss of control.**
- **Do not use the product when visibility is limited.**
- **Do not use the product on rain or snow days. Any exposure to moisture (water or snow) may cause erratic operation or loss of control.**
- **Interference may cause loss of control. To ensure the safety of you and others, do not operate in the following places:**
 - Near any site where other radio control activity may occur
 - Near power lines or communication broadcasting antennas
 - Near people or roads
 - On any body of water when passenger boats are present
- **Do not use this product when you are tired, uncomfortable, or under the influence of alcohol or drugs. Doing so may cause serious injury to yourself or others.**
- **The 2.4GHz radio band is limited to line of sight. Always keep your model in sight as a large object can block the RF signal and lead to loss of control.**
- **Never grip the transmitter antenna during operation. It significantly degrades signal quality and strength and may cause loss of control.**
- **Do not touch any part of the model that may generate heat during operation, or immediately after use. The engine, motor or speed control, may be very hot and can cause serious burns.**



- **Misuse of this product may lead to serious injury or death. To ensure the safety of you and your equipment, read this manual and follow the instructions.**
- **Make sure the product is properly installed in your model. Failure to do so may result in serious injury.**
- **Make sure to disconnect the receiver battery before turning off the transmitter. Failure to do so may lead to unintended operation and cause an accident.**
- **Ensure that all motors operate in the correct direction. If not, adjust the direction first.**
- **Make sure the model flies within a certain distance. Otherwise, it would cause loss of control.**

2. Introduction

This product uses the 2.4GHz Third Generation AFHDS 3 protocol. The NB4 and FGr4 constitute a 4 channel system, compatible with model cars, boats and other models.

2.1 System Features

AFHDS3 (third-generation automatic frequency hopping digital system) is a newly developed digital wireless system. It is compatible with single antenna bidirectional real-time data packet transmission and data stream transmission. With the advantages that come with the WS2A wireless system and the new 2.4GHz chip, the system can dynamically set: number of channels, channel resolution, range, anti-interference requirements and latency to meet the needs of different users.

Single Antenna Bidirectional Real-time Data Transmission

The receiver can receive data from the transmitter and the transmitter can receive data from the receiver, this includes data from sensors, such as temperature and speed and support the i-BUS. This gives more control over the aircraft and constant information on its current status.

Uncorrected Data Transmission

The independent uncorrected data transmission module is built into RF system; it can send many different types of data including flight control data.

Intelligent RF configuration

Depending on hardware, certification, the amount of data to be transmitted, anti-interference, latency and distance requirements, the system intelligently adapts the corresponding RF configuration to meet the requirements of the user.

Multi-channel Frequency Hopping

This systems bandwidth ranges from 2.402GHz to 2.480GHz. This band is divided in 140 channels. Each transmitter hops between 16 channels (32 for Japanese and Korean versions) in order to reduce interference from other transmitters.

Unique ID Recognition System

Each transmitter and receiver has it's own unique ID. Once the transmitter and receiver have been paired, they will only communicate with each other, preventing other systems accidentally connecting to or interfering with the systems operation.

Low Power Consumption

The system is built using highly sensitive low power consumption components, maintaining high receiver sensitivity, while consuming as little as one tenth the power of a standard FM system, dramatically extending battery life.

2.2 Transmitter Overview

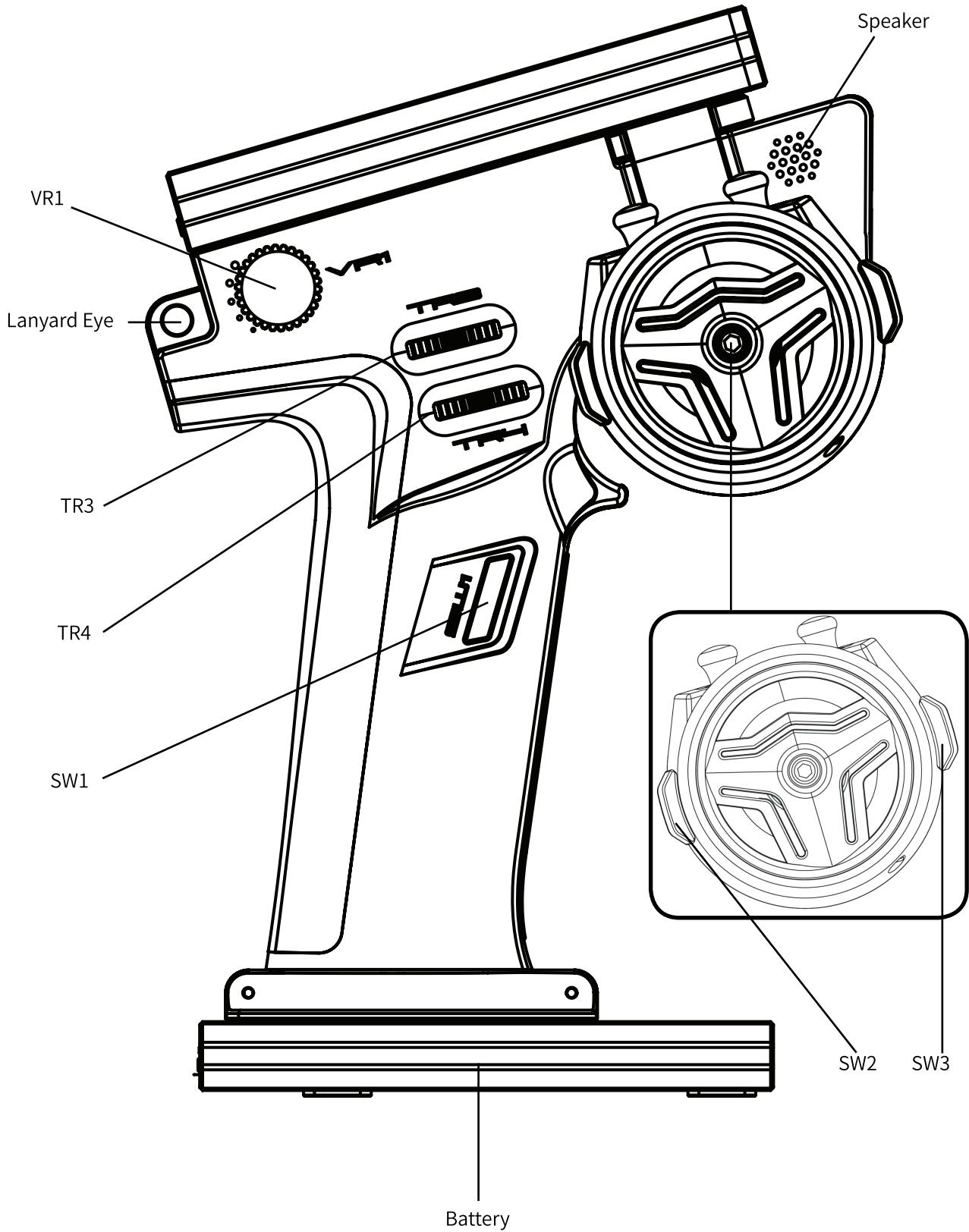

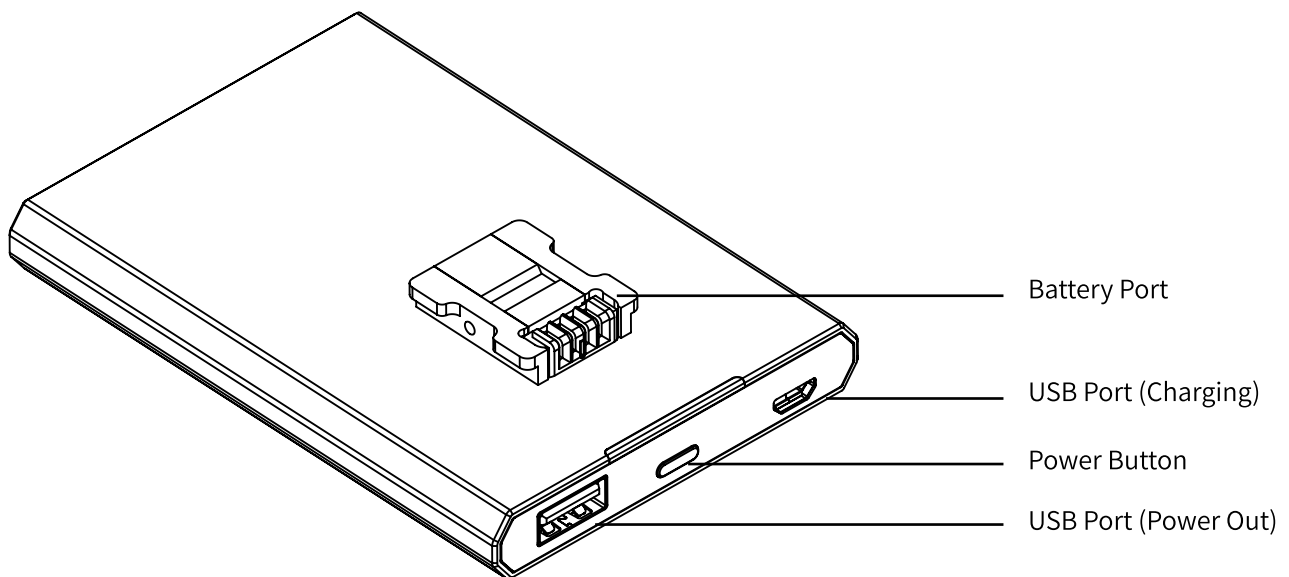
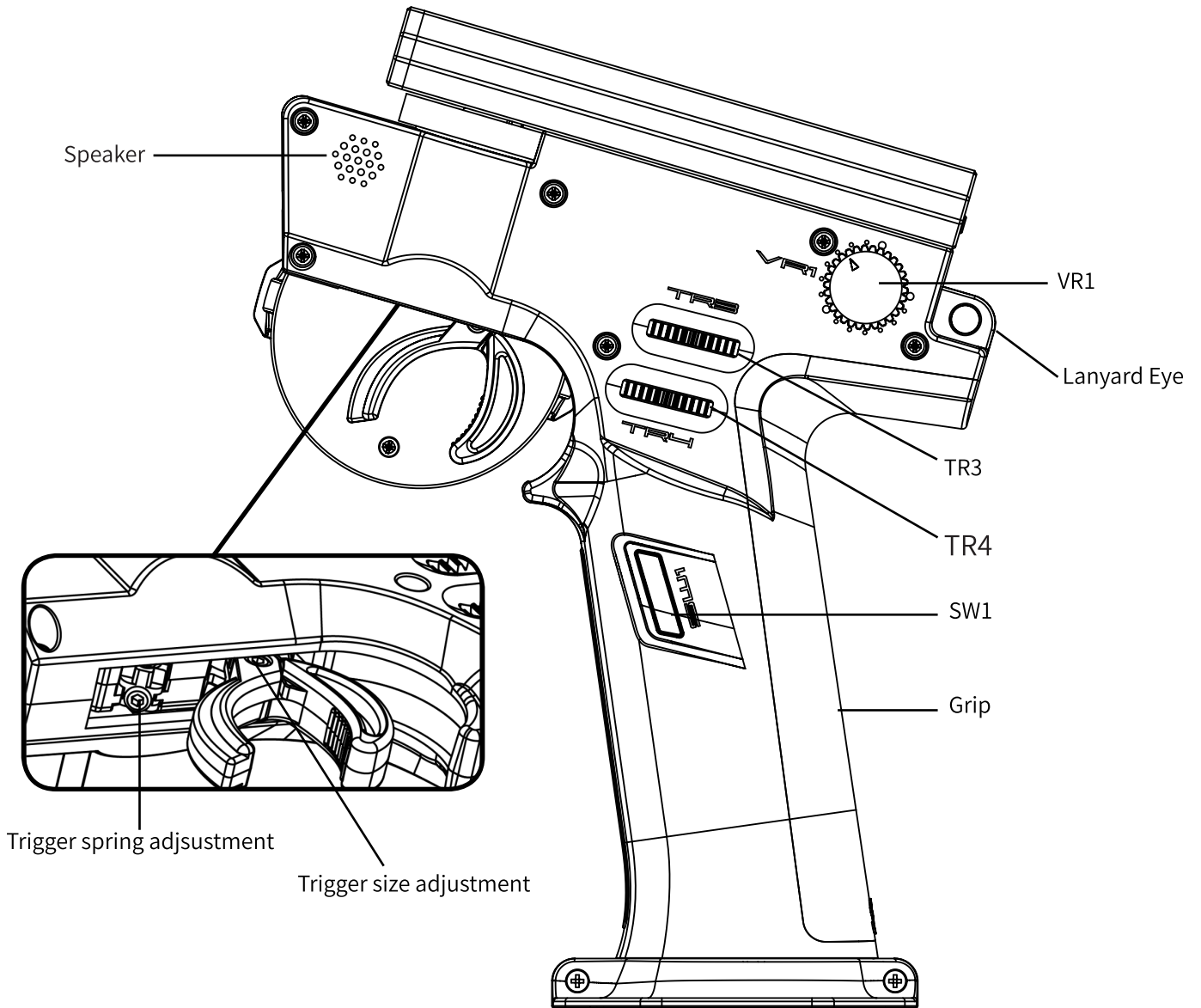

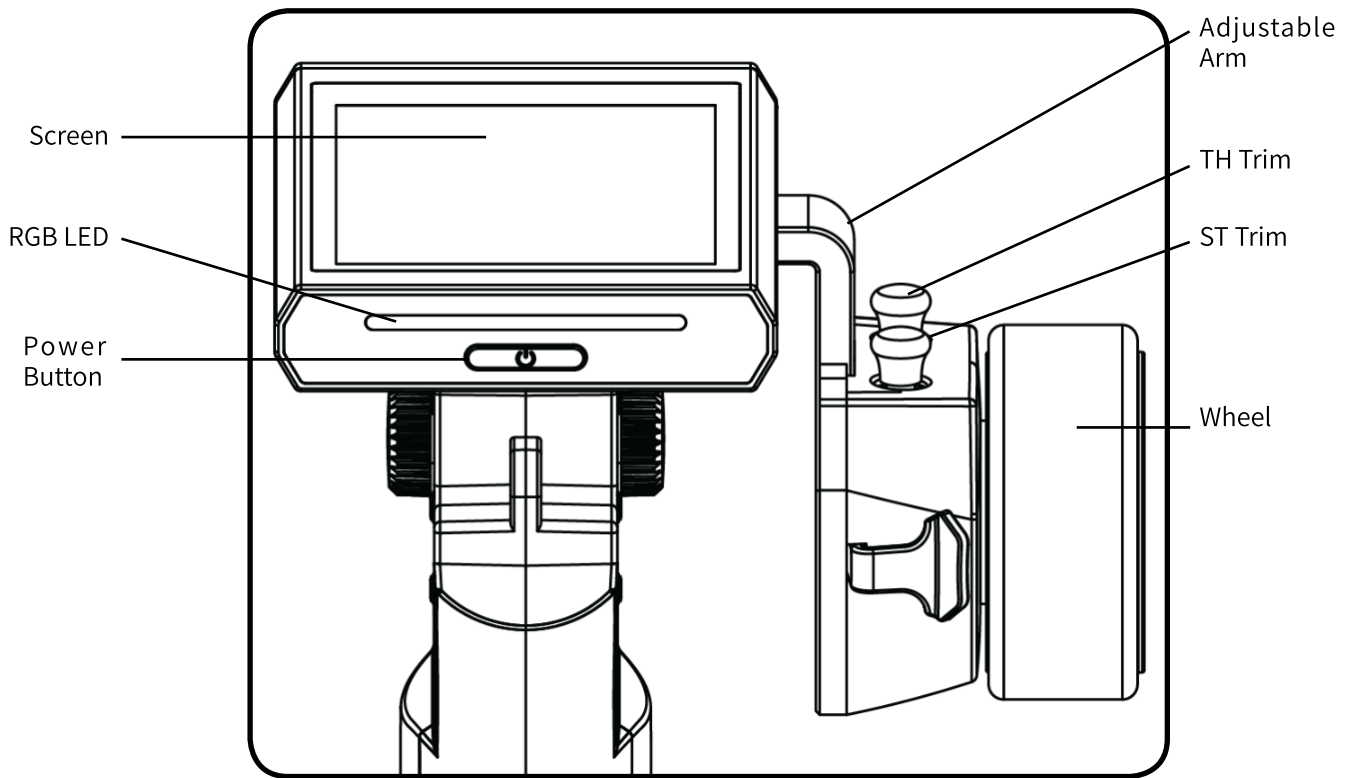

Trigger Position Adjustment Screw

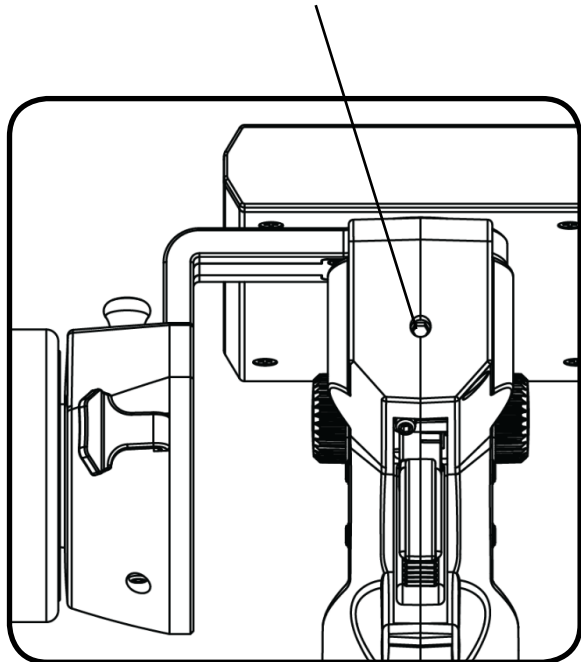

Wheel Tension Adjustment Screw

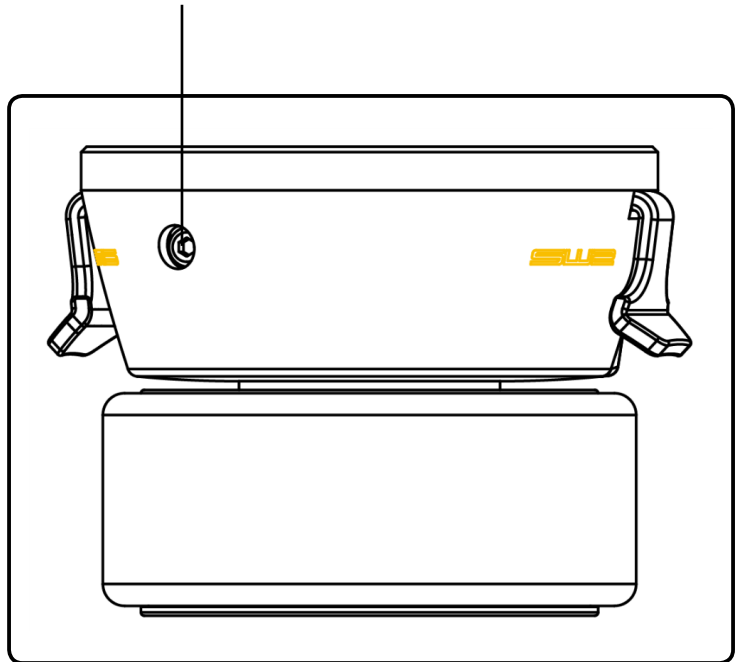

2.3 Receiver Overview

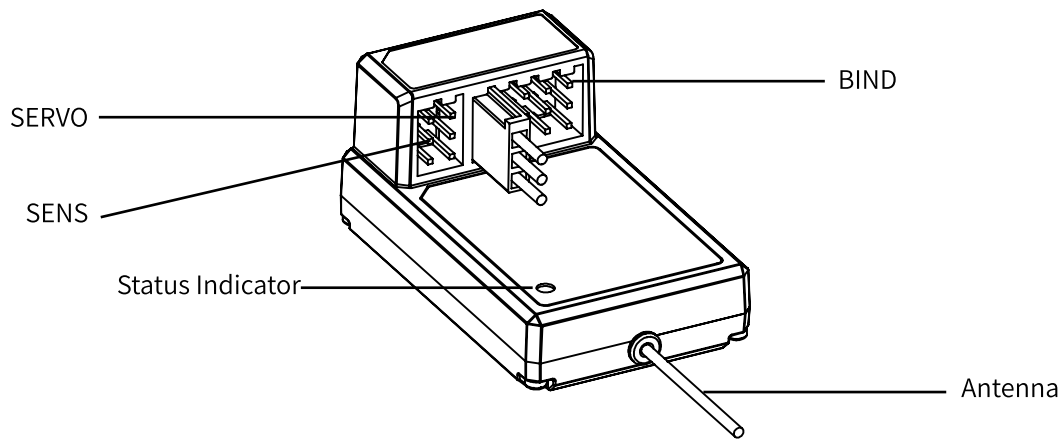

2.3.1 Status Indicator







The status indicator is used to indicate the power and working status of the receiver.

- Off: The power is not connected.
- Lit in red: The receiver is on and working.
- Flashing quickly: The receiver is binding.
- Flashing slowly: The bound transmitter is off or signal is lost.

3. Getting Started

Before operation, install the battery and connect the system as instructed below.

3.1 Transmitter Battery Installation

 Danger	• Only use included batteries
 Danger	• Do not open, disassemble, or attempt to repair the battery.
 Danger	• Do not crush/puncture the battery, or short the external contacts.
 Danger	• Do not expose to excessive heat or liquids.
 Danger	• Do not drop the battery or expose to strong shocks or vibrations.
 Danger	• Always store the battery in a cool, dry place.
 Danger	• Do not use the battery if damaged.

The NB4 has 2 batteries, one located in the handle and one in the removeable base.

To attach the base:

1. Line up the base so that the transmitter handle has a slight over hang on the back.
2. Carefully insert the base contacts into the hole in the bottom of the handle.
3. Hold the handle firmly and pull the battery backwards. When it is secure you should hear a click.

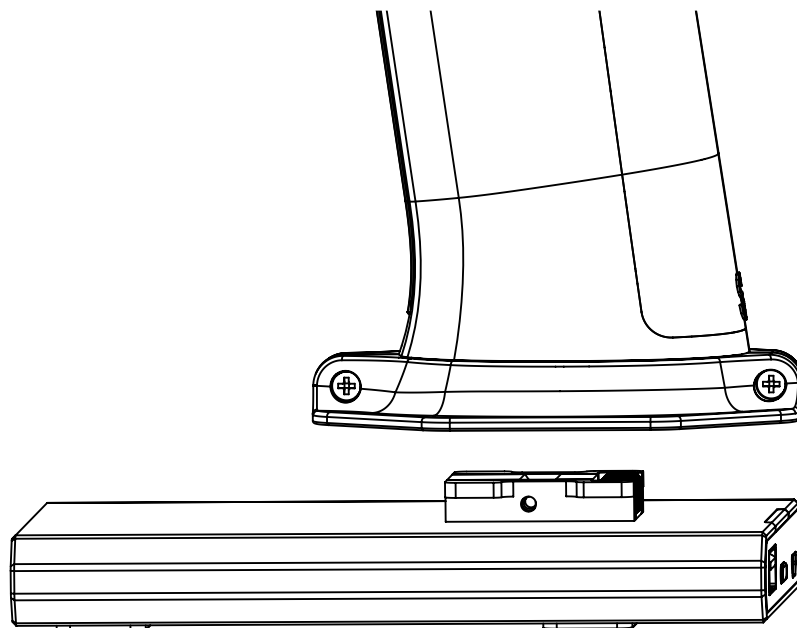



4. Operation Instructions

After setting up, follow the instructions below to operate the system.

4.1 Power On

Follow the steps below to turn on the transmitter:

1. Make sure that:
 - The battery is fully charged and installed correctly.
 - The receiver is installed correctly and powered down.
2. Hold the power button until the screen turns on.
3. Connect the power supply to the receiver.

 Note	<ul style="list-style-type: none">• Operate with caution in order to avoid damage or injury.
 Note	<ul style="list-style-type: none">• Make sure that the throttle is at its lowest position and the switches are set to their up position.

4.2 Binding

The transmitter and receiver have been pre-bound before delivery.

If you are using another transmitter or receiver, follow the steps below to bind the transmitter and receiver:

1. Connect the bind cable to the receiver's B/VCC port.
2. Connect power to any other port.
3. Select "Bind With A Receiver" in the transmitter's RX Setup menu.
4. Once binding is complete the transmitter will exit bind mode. Remove the power and bind cable from the receiver then apply power to the B/VCC port.
5. Check to make sure everything functions as expected. If not repeat the steps above.

4.3 Transmitter LED Indicator

This LED has six colors, green, blue, cyan, red, yellow, white and off which can be set according to user preference.

To change the LED color see the LED Strip section of this user manual.

4.4 Power Off

Follow the steps below to turn off the system:

1. Disconnect the receiver power.
2. Hold the transmitters power button until the screen turns off.

 Danger	<ul style="list-style-type: none">• Make sure to disconnect the receiver power before turning off the transmitter. Failure to do so may lead to damage or serious injury.
---	--

5. System Interface

The main interface mainly displays information related to the model, such as transmitter voltage information, function status and so on.

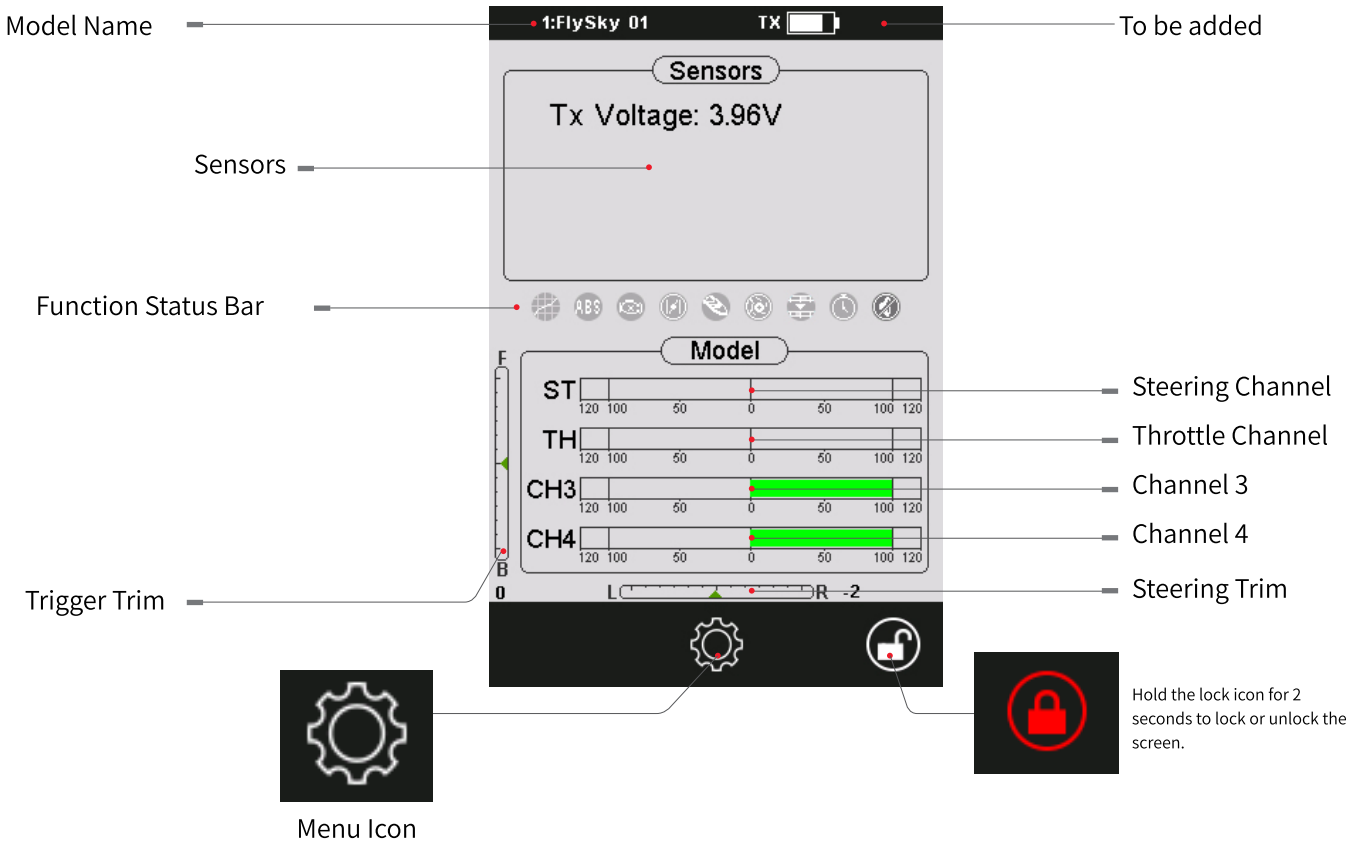

Function Status Bar

The function status bar displays the status of various functions. If the function is a darker color then it is active, if it is slightly see through then it is inactive.

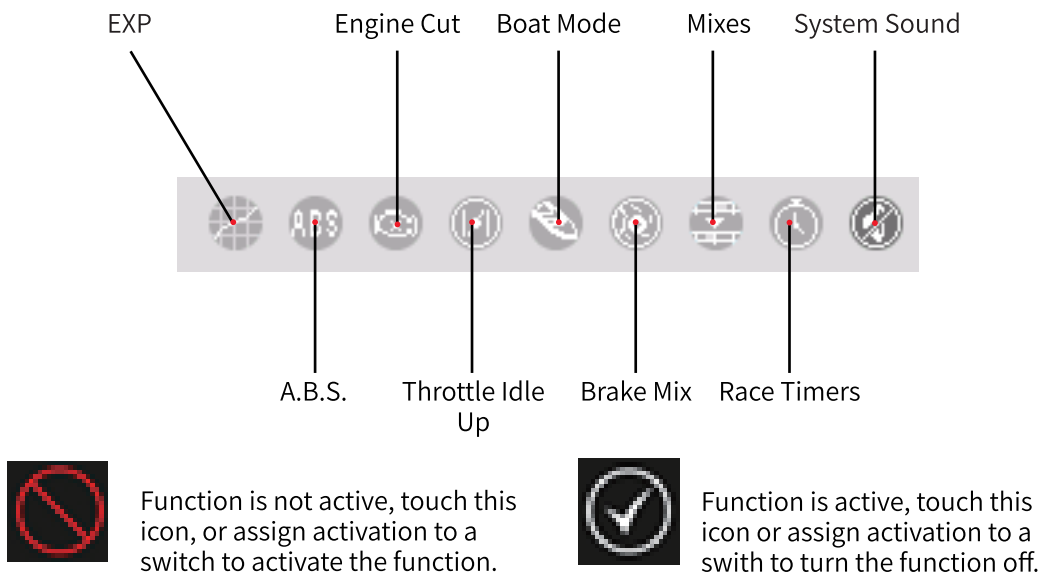

6. Function Settings

This section details functions and their use.

6.1 Reverse

The Reverse function is used to correct a servo or motor's direction in relation to the systems controls. For example, if a steering servo is mounted upside down in order to fit inside a model, when the system's steering wheel is turned, the servo will move in the opposite direction. To fix this, all we need to do is reverse CH1.

Use:

1. Touch the box next to the channels name. If the channel is in normal mode the box will display "NOR", if it is reversed it will display "REV".
2. Test to make sure everything is working as expected.

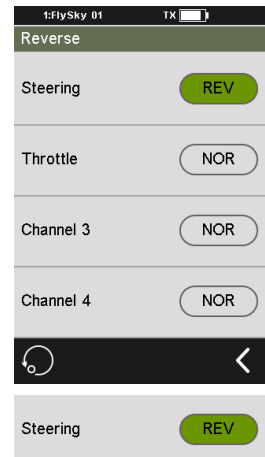

6.2 End Points

Endpoints are the limits of the channels range of movement. There are two endpoints, a low endpoint and a high endpoint.

Setup:

1. Touch a low or high endpoint box on a channel or move the control to the diection you wish to limit. The selected endpoint will be highlighted in green.
2. Use the + and - keys to change the end point position. The maximum is 120% and minimum is 0%.
3. Test to make sure everything is working as expected.

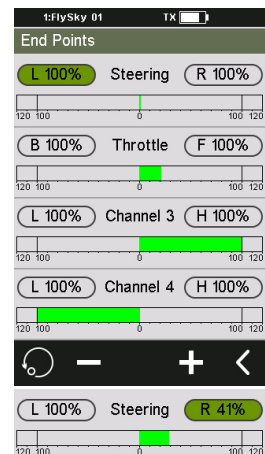

6.3 Subtrim

Subtrim is used to change the center point for each channel. For example, if a car' s wheels are slightly out of aline-ment, even when the transmitter wheel is not being touched, subtrim can be used to correct the alignment.

Setup:

1. Touch the box next to the channel name to select it. When selected the box will be highlighted in green.
2. Use the + and - keys to change subtrim position.
3. Test to make sure everything is working as expected.

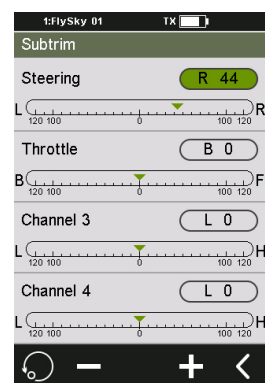

6.4 Steering Exponential

This function changes the steering channel's response curve. There are 2 main parameters:

- **Rate:** Changes the outer limits of the steering, the default and maximum is 100%.
- **Exp. (Exponential):** Changes the steering curve, which changes the response of the steering wheel. The Exp. setting can be positive or negative.

Changes to the rate and exponential can be seen on the graph located in the center of the screen. The system also gives a real-time readout of the channel's current position.

Setup:

1. Touch rate or EXP.
2. Use the + and - icons to raise or lower the percentage as needed.
3. Repeat for the other setting as needed.
4. Test to make sure everything is working as expected.

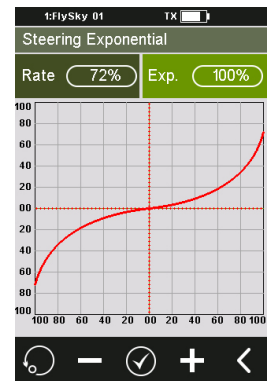

6.5 Steering Speed

Steering Speed changes the speed that the steering channel moves. This function is also used to simulate a realistic wheel turn speed for scale models.

Turn Speed: Slows down the steering movement when moving away from the center point.

Return Speed: Slows down steering movement when moving towards the center point.

Setup:

1. Touch "Turn Speed" or "Return Speed" to select it. When selected the box will turn green.
2. Use the + and - icons to change the turning speed percentage.
3. Repeat with other setting as needed.
4. Test to make sure everything works as expected.

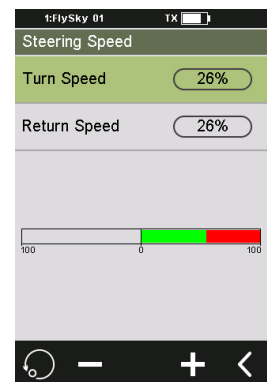

6.6 Steering Mix

This function changes which wheels are involved in steering, front, rear, or 4-wheel steering. It is set to [Standard] by default, which means front wheel steering.

To change steering mode select "Crawler" then select the desired steering type.

Note: In crawler mode, CH3 cannot be controlled independently.

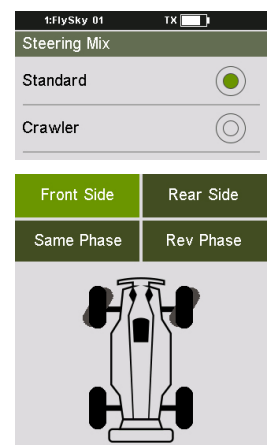

6.7 Throttle Neutral

Throttle Neutral creates a configurable dead zone for the throttle channel.

Forward: How far the dead zone extends into the throttle zone.

Dead Zone: The point at which the channel will kick in when the trigger passes the threshold.

Backward: How far the dead zone extends into the braking zone.

Setup:

1. Touch "Forward", "Dead Zone" or "Backward" to select it.
2. Use the + and - icons to change the percentage as needed.
3. Repeat with other settings as needed.
4. Test to make sure everything works as expected.

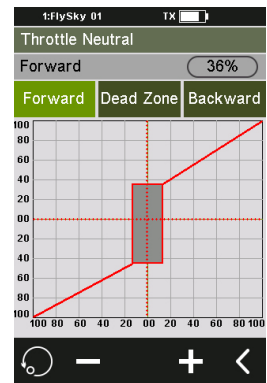

6.8 Throttle Exponential

This function changes the throttle channel's response curve. There are 2 main parameters:

- Rate: Changes the outer limits of the steering, the default and maximum is 100%.
- Exp. (Exponential): Changes the **steering curve**, which changes the response of the throttle. The Exp. setting can be positive or negative.

Changes to the rate and exponential can be seen on the graph located in the center of the screen. The system also gives a real-time readout of the channel's current position.

Setup:

1. Touch rate or EXP.
2. Use the + and - icons to raise or lower the percentage as needed.
3. Repeat for the other setting as needed.
4. Test to make sure everything is working as expected.

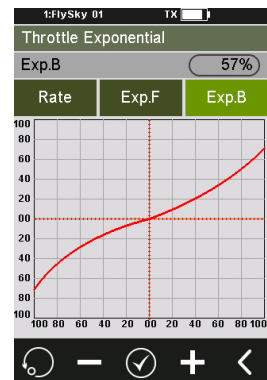



6.9 Throttle Curve

This function changes the shape of the throttles response curve. There are 2 main parameters:

There are 5 editable points, L, 1, 2, 3, 4 and H. As the line is edited the throttle will then follow the new curve value as the throttle moves along the x axis of the graph.

Setup:

1. Touch the  icon to enable the function. The icon will change to  when enabled.
2. Touch a point.
3. Use the + and - icons to raise or lower the points position as needed.
4. Repeat for the other points as needed.
5. Test to make sure everything is working as expected.

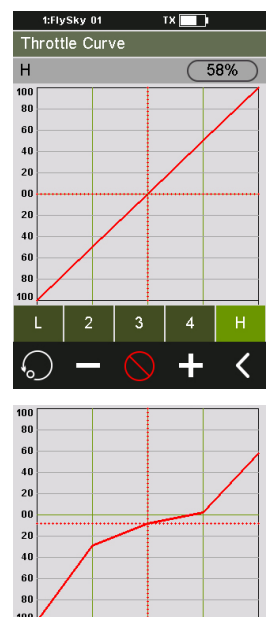

6.10 A.B.S.



A.B.S. stands for auto braking system. This function is used to stop the wheels from locking which can lead to loss of control or a skid. A.B.S. manages this by regulating the amount of pressure the breaks use, which is done by pumping the breaks on and off rather than a constant force.

There are six sub menus for A.B.S. function setting, [Brake return], [Delay], [Cycle length], [Trigger point], [Duty cycle], and [Steering mix].

In the submenus, pulses are shown as a square wave, the peaks indicating brake on, and troughs indicating reduction in braking. As the value changes, the square wave will change to represent the function's current settings.

The trigger point is represented as a white line on the graph.

Below the graph is a bar that shows the real-time braking position. When this function is active and the brake is applied, the green bar will oscillate in real time showing the A.B.S. in action.

To activate this function press the  icon. The icon will change to  when active.



Break Return

Controls the reduction of braking during each pulse. If set to 60%, when the brakes are active; the system will remove 60% of the brakes strength on each pulse.

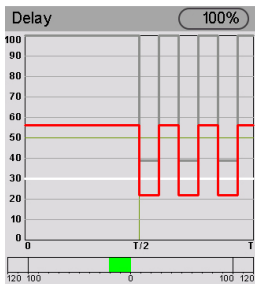
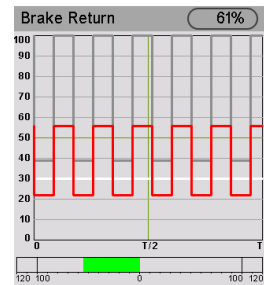

Delay

Determines how long it takes for the A.B.S. system to take effect. At a setting of 0%, the A.B.S. system will take effect as soon as the brake is applied. The higher the value, the longer it will take for the A.B.S. to function.

Cycle Length

Increases or decreases the time between pulses. The higher the value, the longer the pulse.

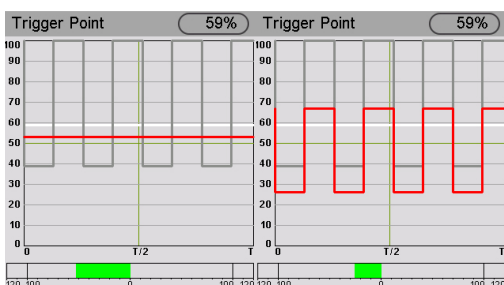
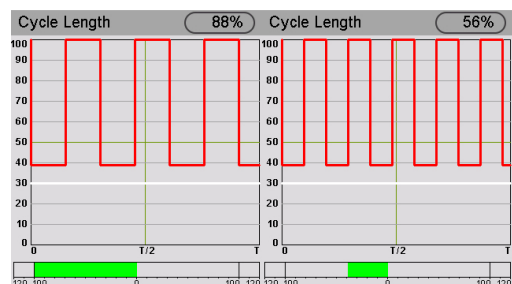

Trigger Point

Configures the point at which the A.B.S. starts to function. The higher the percentage, the further the trigger has to be moved to activate the A.B.S.

Duty Cycle

Changes the length of each pulse and the gap between them. As the value changes, the length of the braking waves peaks and troughs will change independently of each other and will no longer be symmetrical.

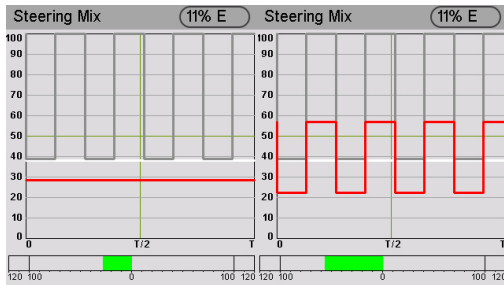
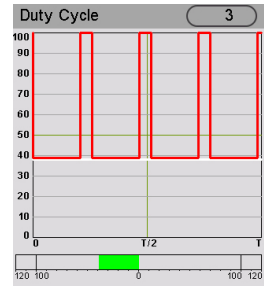

Steering Mix

A.B.S. can be reduced automatically while turning. This function mixes braking and steering to turn reduce the A.B.S. or replace it with a constant braking pressure.

6.11 Throttle Speed

Throttle Speed changes how quickly the throttle will react, for both braking and throttle.

There are 2 settings for brake and throttle:

- Go: Sets how quickly the throttle applies acceleration.
- Return: Sets how quickly the throttle backs off.

The lower the percentage the longer it will take for the throttle to catch up with the trigger movement.

The bar in the middle of the screen will show the throttle's current position in real time. The red bar is the triggers current position; the green bar is the channels current position.

Setup:

1. Select the desired setting, [Go] or [Return].
2. Use the + or - icons to change the percentage.
3. Repeat with the other settings as needed.
4. Test to make sure everything works as expected.

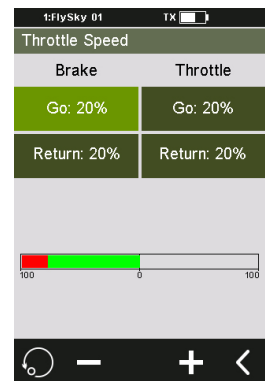

6.12 Throttle Middle

This function changes the midpoint of the throttle, and could be used to correct the servo position. If the servo position is wrong, the model may move as soon as it's turned on.

Setup:

1. Use the + and - keys to change the throttle middle position.
2. Test to make sure everything is working as expected.

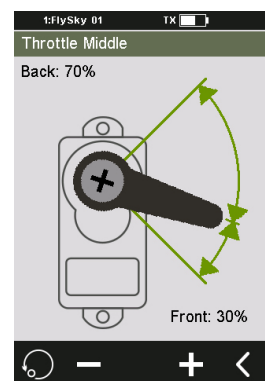

6.13 Throttle Idle Up

Throttle Idle Up is used for models that use a fuel based engine that will stall if left at 0 throttle. Idle up makes sure that the engine always has some throttle in order to keep it from stalling.

This function must be assigned to a switch/button in order to be activated (See [Buttons Assign]). If not, the function cannot be activated.

Setup:

1. Assign the Throttle Idle Up function to a button. For more information on this see the [Buttons Assign] section of this user manual. Now when the button is press it will toggle Throttle Idle Up on and off.
2. Use the + and - icons to change the percentage.
3. Test to make sure everything works as expected.

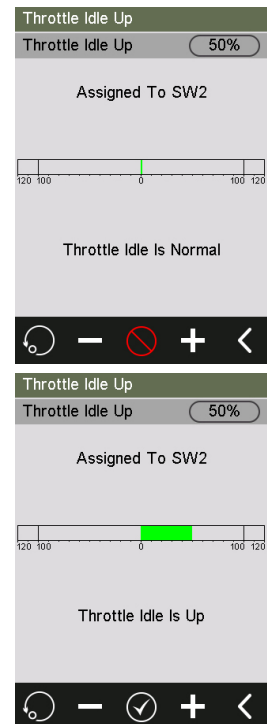

6.14 Engine Cut

When Engine Cut is triggered via a button it sets the throttle channel to a predefined position.

This function must be assigned to a switch/button in order to be activated (See [Buttons Assign]). If not, the function cannot be activated.

Setup:

1. Assign the Engine Cut function to a button. For more information on this see the [Buttons Assign] section of this user manual. Now when the button is press it will toggle Engine Cut on and off.
2. Use the + and - icons to change the percentage.
3. Test to make sure everything works as expected.

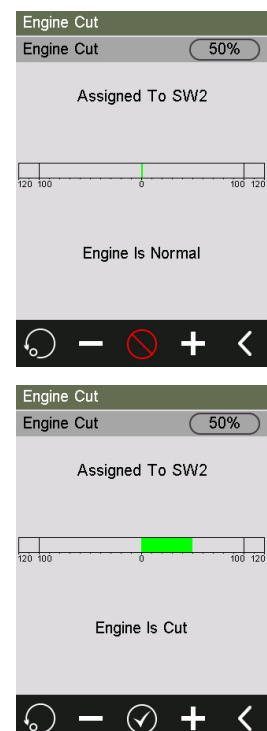

6.15 Boat Mode

This function is used only when you are using a model boat. When this function is active, the throttle channel is set to its lowest position and the brake functionality is disabled.

To toggle this function, select the box beside [Normal mode]. When the function is active, the text beside the box will change to [Boat mode].

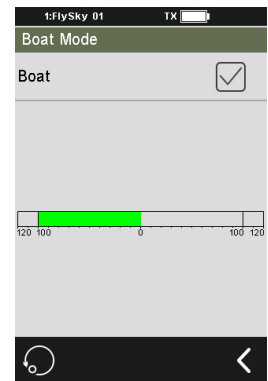

6.16 Brake Mixing

This function enables you to use models that require more than one braking channel, for example a model that has separate brakes for front and back braking.

If your model uses extra channels for braking, each channel can be controlled separately and are slaves of the throttle channel.

Setup:

1. Touch channel 3 or 4 to reveal that channels options.
2. Touch the exponential option to enter the exponential settings.
3. Touch rate and use the + and - icons to change the percentage and do the same for Exp.
4. Touch the icon to return to the brake mixing main menu.
5. Touch A.B.S. to enter the sub menu.
6. Refer to the [A.B.S.] section of the user manual for more information on how to set up A.B.S.
7. Use the Display Servos function to make sure everything is working as expected.

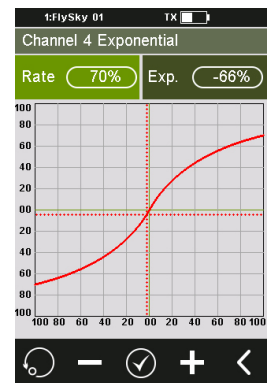
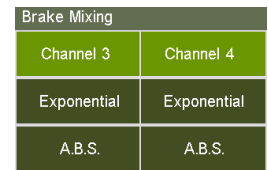

6.17 Mixes

Mixes is used to create a mix between channels.

Setup:

1. Touch a mix to select it.
2. Touch the icon to enable the function. The icon will change to when enabled.
3. Touch "Master Channel", then select a master channel from the list.
4. Touch "Slave Channel", then select a slave channel from the list.
5. Select [Low side mix] or [High side mix] as needed. Use the + and - icons to change the mix percentage. Press the icon when finished to return to the mix menu.

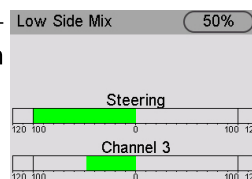

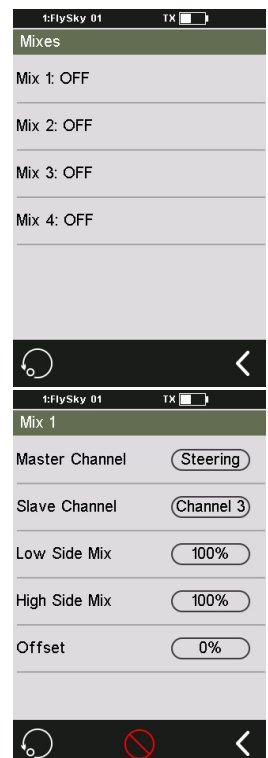

6. Repeat step 5 for the other mix as needed.

7. Touch offset, then use the + and - icons to change the slave channels offset relative to the master.



6.18 Display Servos

This function displays the model's channel output and can be used to test output and servo range.

Press the icon  to start servo test mode, which will move all the channels slowly through their entire range of motion. Press the  icon to turn off servo test mode.

WARNING:

Make sure the model engine is powered off while the test function is activated.

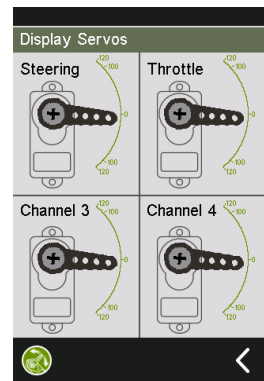

6.19 Race Timers

Modes:

- Up Timer: Counts up.
- Down Timer: Counts down from the set time. Use the + and - icons to set a time to count down from.
- Lap Timer: Keeps track time for each individual lap.
- Lap Memory: Records the results from the lap timer.

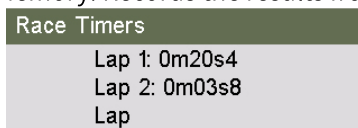

Setup:

Touch "Start" to start the timer, "Stop" to stop.

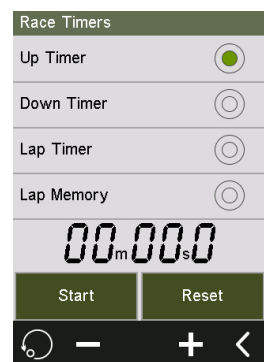

6.20 Buttons Assign

This function assigns the system's physical buttons to different functions for quick control.

Setup:

1. Touch a switch, button, wheel or trim from the diagram.
2. Select a function from the list.

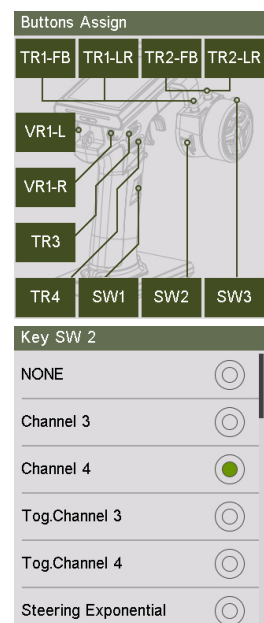

6.21 Models

This function is used to change, reset, rename or copy model setups. The NB4 can store up to 20 different models in the internal memory.

Selecting a model: To select a model touch "Select Model", then touch a model from the list.

Naming a model: To rename a model touch "Name:", then use the on screen keyboard to enter a new name. Press the  icon when finished to return to save and return to the previous menu.

Copying a model: Touch "Copy Model", then touch the model to copy from the list. Next select a target slot from the list, this will overwrite everything in that slot. The system will ask if you are sure, select yes.

Resetting a model: To reset a model touch "Model" reset, then select the model you wish to reset from the list. The system will ask if you are sure, select yes.

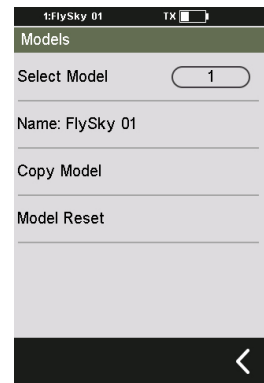

7 RX Setup

7.1 Bind With A Receiver

To bind with a receiver:

1. Put the receiver into bind mode (Check the receiver's user manual for your receiver on how to enter bind mode).
2. Touch "Bind With A Receiver" in the RX Setup menu. The NB4 will now bind with the receiver and exit automatically when binding is complete.

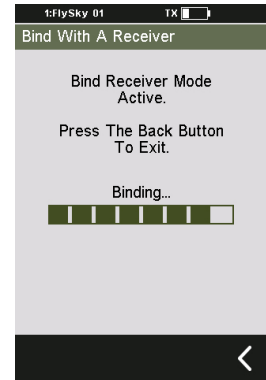

7.2 Failsafe

This function is used to protect the models and users if the receiver loses signal and therefore is no longer controllable.

Setup:

1. Select a channel by touching the box to the right of the channel name. The box will be highlighted in green when selected.
2. Move the channel to the desired location, hold it in that position, then press the  icon.

To set all channels at the same time, touch "All Channels", move all the channels and hold them in the desired location, then press the  icon to save.

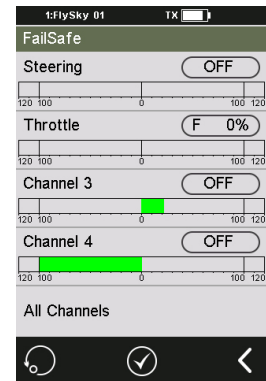

8 System

8.1 Backlight Timeout

The backlight timeout function controls how long the system will wait before turning off screens backlight.

Setup:

1. Select a time from the list.

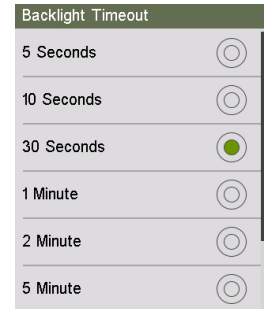

8.2 Backlight

This function controls the backlight brightness.

Setup:

1. Use the + and - icons to change the backlight percentage.
2. Touch the  icon to save and return to the previous menu.

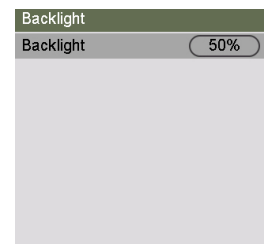

8.3 Sound

This function is used to toggle all system sounds, including power-on/power-off sounds, key sounds and so on.

Volume: Touch volume then select the desired volume from the list. Touch the  icon to return to the previous menu.

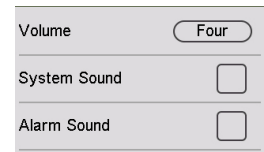

System Sound: Toggle system sounds by touching the box to the right of "System sound". If there is a check in the box it is enabled.

Alarm Sound: To turn off alarms and alerts touch the box to the right of "Alarm sound". If there is a check in the box it is enabled.

8.4 Vibration

Vibration sets the various vibration functions available for the system.

Vibrate Level: Touch "Vibrate Level" then select the desired strength from the list. Touch the  icon to return to the previous menu.

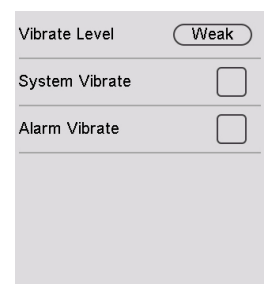

System Sound: Toggle system sounds by touching the box to the right of "System sound". If there is a check in the box it is enabled.

Alarm Sound: To turn off alarms and alerts touch the box to the right of "Alarm sound". If there is a check in the box it is enabled.

8.5 LED

LED Light changes the color of the LED strip located above the power button.

Changing Color:

1. Touch LED Light to enter the menu.
2. Select a color from the list.
3. Touch the  icon to return to the previous menu.

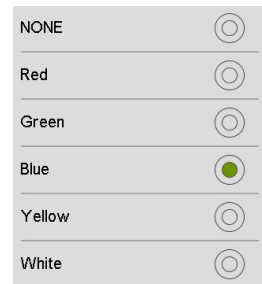

8.6 Language

Language changes the language for the user interface.

Changing Language:

1. Touch "Language" to enter the menu.
2. Select a language from the list.
3. Touch the  icon to return to the previous menu.

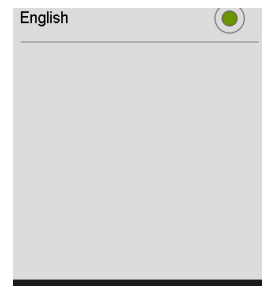

8.7 Auto Power Off

Auto Power Off will turn off the transmitter if no receiver is connected and the user has not done anything for 2 minutes.

To toggle Auto Power Off touch the box to the right of the setting. If there is a check in the box the function is active.



8.8 Radio Frequency Setup

Radio Frequency Setup contains the RF protocol settings for the transmitter and receiver.

Change RF Protocol:

1. Touch "RF Std. :" and select a protocol from the list.
2. Touch the  icon to return to the previous menu.

Update RF:

Update RF updates the internal RF module. The update will be contained within a firmware update for the NB4. To update touch "Update RF", a progress bar will appear and after a few seconds the update will complete.

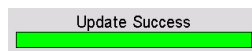
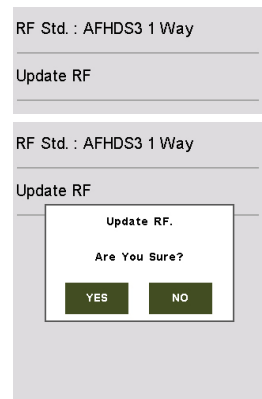

8.9 Stick Calibration

Stick Calibration calibrates the trigger and wheel so that their center and outer positions are correct. The green bar is the channels current position and the calibrated range will be grey like the background.

Calibration:

1. Move the wheel and trigger as far as they can go in each direction.
2. Touch the  icon to save and return to the previous menu.

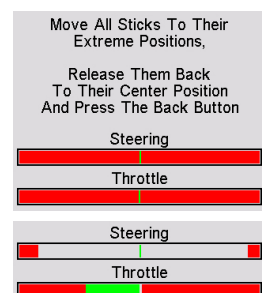

8.10 Firmware Update

The internal software of the transmitter can be updated using the USB interface connected via a windows computer. Once this function is activated, all functions of the transmitter stop. To avoid any loss of control of the vehicle, turn its receiver off before entering this mode.

When the firmware is updating, never disconnect the USB cable or remove the battery or the transmitter.

1. Download and open the newest official software.
2. Connect a transmitter with a computer by USB cable.
3. Touch "Firmware Update", then touch "Yes".

8.11 Factory Reset

Factory Reset resets all of the transmitter settings and functions back to their factory default state.

Reset:

Touch "Factory Reset", then touch "YES" when prompted.

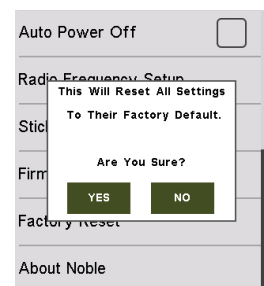

8.12 About Noble

Contains basic information including product name, firmware version, activation date and hardware version.

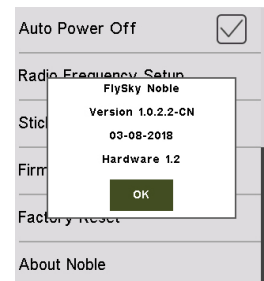

9. Product Specifications

This section contains NB4 transmitter and FGr4 receiver specifications.

9.1 Transmitter specification (NB4)

Model Type	Car, Boat
Channels	4
RF Range	2.402-2.480GHz
RF Power	<20dBm (EU)
RF Standard	AFHDS 3
Data Output	Micro USB
Charging Port	Micro USB
Antenna Type	Built-in Single Antenna
Input Power	1S/4.2V Lithium Polymer Battery
Screen	HVGA 3.5 inch TFT color screen with a resolution of 320*480, LCD white backlight, capacitive touch screen
Online Update	Yes
Range (Ground no interference)	> 300m
Dimensions	129*114*190 mm
Weight	520g
Certification	CE, FCC ID:N4ZFG400

9.2 Receiver Specification (FGr4)

Channels	4
RF range	2.402-2.480 GHz
RF Standard	AFHDS 3
RF Power	<20dBm (EU)
Power input	3.5V-12V
Weight	15g
Dimensions	46 * 28 * 22 mm
Certificate	CE, FCC ID:N4ZFGR400

10. Package Contents

NB4 Transmitter	x 1
FGr4	x 1
Quick Start Guide	x 1
USB Wire	x 1
Hand Grip L	x 1
Bluetooth module	x 1 (optional)
Ibus Module	x 1 (optional)

11. Certification

11.1 DoC Declaration

Hereby, [Flysky Technology co., ltd] declares that the Radio Equipment [Noble(NB4),FG4] is in compliance with RED 2014/53/EU.

The full text of the EU DoC is available at the following internet address: www.flysky-cn.com

11.2 CE Warning

The antenna(s) used for this transmitter must be installed to provide a separation distance of at least 20 cm from all persons and must not be co-located or operating in conjunction with any other transmitter. End-users and installers must be provided with antenna installation instructions and transmitter operating conditions for satisfying RF exposure compliance

11.3 Environmentally friendly disposal

Old electrical appliances must not be disposed of together with the residual waste, but have to be disposed of separately. The disposal at the communal collecting point via private persons is for free. The owner of old appliances is responsible to bring the appliances to these collecting points or to similar collection points. With this little personal effort, you contribute to recycle valuable raw materials and the treatment of toxic substances.



CAUTION

RISK OF EXPLOSION IF BATTERY IS REPLACED BY AN INCORRECT TYPE.
DISPOSE OF USED BATTERIES ACCORDING TO THE INSTRUCTIONS

11.4 Appendix 1 FCC Statement

This equipment has been tested and found to comply with the limits for a Class B digital device pursuant to part 15 of the FCC rules. These limits are designed to provide reasonable protection against harmful interference in a residential installation. This equipment generates, uses and can radiate radio frequency energy and, if not installed and used in accordance with the instructions, may cause harmful interference to radio communications. However, there is no guarantee that interference will not occur in a particular installation. If this equipment does cause harmful interference to radio or television reception, which can be determined by turning the equipment off and on, the user is encouraged to try to correct the interference by one or more of the following measures:

Reorient or relocate the receiving antenna.

Increase the separation between the equipment and receiver.

Connect the equipment into an outlet on a circuit different from that to which the receiver is connected.

Consult the dealer or an experienced radio/TV technician for help.

To assure continued compliance, any changes or modifications not expressly approved by the party responsible for compliance could void the user's authority to operate this equipment.

This equipment complies with Part 15 of the FCC Rules. Operation is subject to the following two conditions:

- (1) This device may not cause harmful interference, and
- (2) This device must accept any interference received, including interference that may cause undesired operation.

Caution!

The manufacturer is not responsible for any radio or TV interference caused by unauthorized modifications to this equipment. Such modifications could void the user authority to operate the equipment.

1. Move all your channels to the desired position.
2. Select [All channels] and then [Yes] in the confirmation box.



www.flysky-cn.com

Copyright ©2018 Flysky Technology co., ltd

Release date: 2019-08-07



FCC ID: N4ZFG400