

Noble NB4



Quick Start Guide

Precaution !

For your own safety: make sure to download and read the Disclaimer & Warning documentation from the Flysky website before using this product.

Flysky Website: www.flysky-cn.com

1. For best signal quality the transmitters antenna must be kept at least 20 cm away from all your body and must not be juxtaposed or operated close to other transmitters. Antenna installation instructions and transmitter operating conditions that meet RF signal emissions must be provided to end users and installers.
2. Hereby, [Flysky Technology co., Ltd] declares the RF equipment [Noble (NB4), FG4] to be in accordance with RED2014/53/EU.
3. The full text of the EU DoC is available at: www.flysky-cn.com.

Front View:

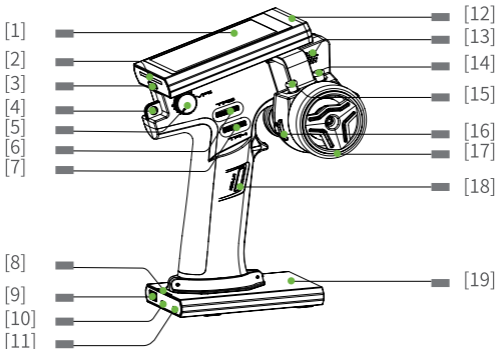

- | | |
|------------------------------|---|
| [1] Display | [11] USB data/update port |
| [2] Transmitter LED | [12] Built-in Antenna |
| [3] Transmitter Power Button | [13] Speaker |
| [4] Lanyard Eye | [14] TR2 (throttle trim) |
| [5] VR1 | [15] TR1(Steering Trim) |
| [6] TR3 | [16] SW2 |
| [7] TR4 | [17] Steering Wheel (can be rotated 180°) |
| [8] Base Battery Indicator | [18] SW1 |
| [9] 5V USB Port | [19] Detachable Base |
| [10] Base Power Button | |

Rear View:

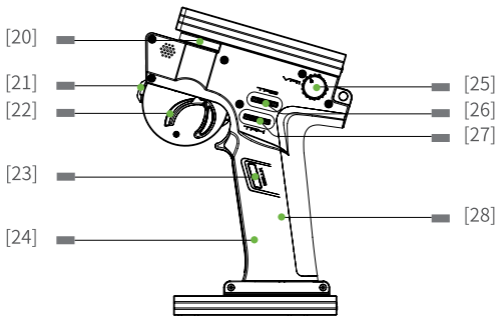

[20] Steering Wheel
Swivel Bracket

[21] SW3

[22] Trigger

[23] SW1

[24] Built-in Battery

[25] VR1

[26] TR3

[27] TR4

[28] Haptic feedback motor
built into transmitter
handle (Vibration type
can be set in the system
submenu "Vibration")

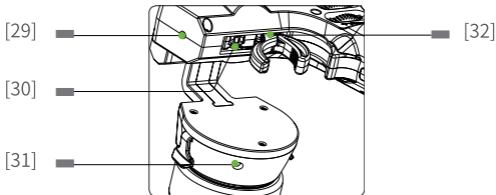

- Note: Do not completely unscrew the adjustment screws.

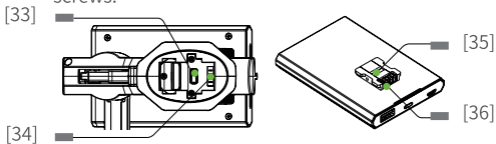

- [29] Adjust trigger stroke length
- [30] Adjust trigger stiffness
- [31] Adjust steering wheel stiffness
- [32] Adjust trigger size

- [33] Spring clip
- [34] Power connector
- [35] Spring snap groove
- [36] Power connector

- For more information , please read the full user manual.

Power On

1. Before use make sure that the battery is fully charged.
2. Press and hold the transmitter power button until the screen turns on.

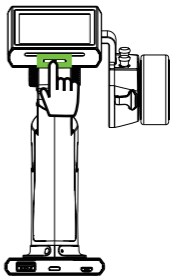



Power Off

1. Disconnect the receiver from its power supply.
2. Press and hold the transmitter's power button until the screen powers off.

! Before powering off the transmitter make sure that the receiver has been powered off first. Powering off the transmitter before the receiver may result in loss of control of a model or engine leading to an accident.

Language Selection

Function Settings:

Touch the function menu icon , touch [System Settings (SYSTEM)] and navigate to [Language]. To select a language touch English (English) or Chinese and touch the back icon  to save and exit.





Failsafe

This feature is designed to protect models and their users in the event of a loss of signal.

All four channels are displayed failsafe menu. If set to [OFF], the channel will remain at its last position before signal loss. If a percentage is displayed, then that channel will move to that percentage when signal is lost. Failsafe is active by default.

Function Settings:

1. Touch the function menu  to enter the function menu, touch [Rx Setup], touch [Failsafe]. Touch the  at the bottom middle of the screen to turn failsafe on or off globally;
2. Touch a channel to enter its failsafe menu. Touch the  at the bottom of the screen to activate failsafe for the chosen channel.
3. Move the wheel, button, knob or trigger to the desired failsafe position and touch the back button to save and exit.

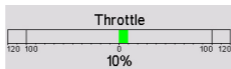

This picture shows the throttle channel set to a failsafe value of 10% forward.

- Each channels failsafe protection needs to be activated within the channels failsafe menu individually.



Attention

- For safety, it is recommended that all users pre-set this function before use.

Servo Frequency

This function is used to adjust the servo control frequency. This function can be used for analog servos (95Hz), digital servos (380Hz) and can also be set to custom frequencies. Digital servos and custom frequencies range between 50-400Hz.

Function settings:

- Go to the function menu and touch the  icon.
- Go to [Receiver Settings] and touch [Servo Frequency].
- Touch to select analog servo, digital servo or custom frequency.
- If you choose a custom frequency, touch "+", "-" to adjust the frequency.

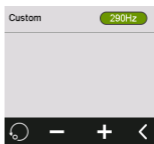

Both the analog servo (95Hz) and the digital servo (380Hz) are common servo frequencies and as such, are available as presets for quick setup. In order for servos to operate normally they must receive the correct frequency, to find the frequency refer to the servos user manual.

Firmware update

The transmitter's firmware can be updated by connecting to a Windows computer using a USB cable. Once this function is activated, all transmitter functions will stop working. To prevent the vehicle from losing control, power off the receiver before attempting to use this function.



warning

- Do not disconnect the USB cable while the firmware is being updated!

How To Update:

1. Download and open the latest official software;
2. Connect the transmitter to the computer via USB first;
3. Click the main interface icon  to enter the function menu and select [System Settings (SYSTEM)];
4. Touch [Firmware Update]. The system will display the warning: “Entering update mode will disable all other functions.” , touch [Yes] to continue.
5. After completing the above steps, the computer update software window pops up as shown below (for reference only), click [Update] to start the update.

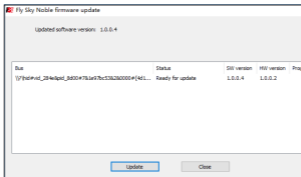



- Once the update is complete, the transmitter will exit the update function automatically and reboot. (It is now safe to remove the USB cable)

 Attention	<ul style="list-style-type: none"> After a firmware update the receiver may not connect. If this is the case the RF module and receiver need to be updated.
---	--

RF Module Update

How To Update:

Click the main interface icon  to enter the function menu and select [System Settings (SYSTEM)]. Touch the function menu icon, then the System settings icon. Navigate to then touch Radio Frequency Setup, then touch [Update RF]. The system will ask “Are You Sure?” , select yes to continue. Touch the back icon  when the update is finished.

Update Receiver

Each transmitter update comes with a receiver update which needs to be uploaded to the receiver to make the most of optimizations and features that are included in the update.

How To Update:

Make sure the transmitter and receiver are bound. Navigate to [Receiver Setting], click [Update Receiver], the system will then display a prompt “Update receiver, are you sure?” . Touch “Yes” to update.

If the receiver is not bound or connected to the transmitter the transmitter will display the prompt “Please connect a receiver or put the receiver into forced update mode” . Touch [Yes] to enter receiver selection. Choose between FGR4 and the FGR4S depending on which receiver you have. (FGR4S needs to be placed upright when in use)

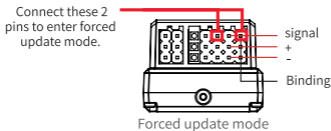

After starting the update, the transmitter will display as below. Once the update as reached 100%, the update is successful.

- The RF module must be updated before updating the receiver.

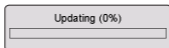

Binding

The transmitter and receiver have already been pre bound at the factory, however if you wish to bind again or bind a new receiver follow the steps below:

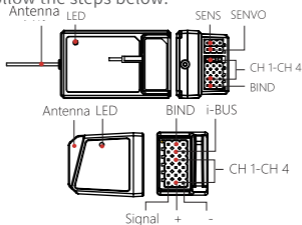

1. Connect the bind cable to the BIND port.
 2. Connect power to any other port on the receiver. Once in bind mode the LED will flash quickly.
 3. Turn on the transmitter, go to [RX SET], then [Bind With A Receiver].
 4. If binding is successful the receivers LED will stop flashing.
 5. On the transmitter touch the back button to exit bind mode. Power off the receiver and remove the bind cable.
 6. Power on the receiver and check to make sure that everything is working as expected. If there are any issues follow the steps above to rebind.
- These steps are only for the Noble transmitter in use with the FGr4 or FGr4S receivers. If you are using other receivers please visit the website for more information.



LED Indicator

The Nobel has 2 status indicators, one below the screen on the top of the transmitter and one on the detachable base.

Transmitter LED

The LED can be set to five different colors: red, green, blue, yellow and white. You can also turn the LED off completely.

Function Settings:

1. Touch the function menu icon , then touch the [System] icon and navigate to LED;
2. Touch [LED];
3. Select a color by touching it. The LED color will be updated in real time.
4. Press the back icon  to save and exit.

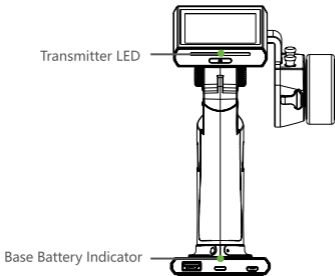

Base Battery Indicator

The Base Battery Indicator has 4 LEDs and is mainly used to display bases battery level.

When the base battery voltage is low, the base LED will only have one LED light on and start flashing.

When charging the LED will flash and the amount of active LEDs will increase as the battery charges.

Key Functions :

Press the power button located on the base to power it on and begin charging the transmitter via the transmitter connector or other 5V devices via the USB port. Press and hold the power button again to turn off the charging function.



Do not charge the base and power other devices off it at the same time. This may increase charge time for the transmitter as well as trigger overload protection if the external device is pulling too much power.

Detachable base

Removeable Transmitter Base

When active the base can power the transmitter, or other 5V external electronic devices via the USB port.

When the transmitter needs to be charged or when charging the base, plug in the USB cable and charge it through the USB port located on the base.



① Lift the base up

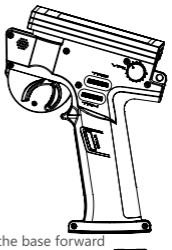

② Push the base forward



③ Remove the base



Recommendation: Noble should not be charged during use.

Specifications

Noble (NB4)	
Suitable Models	Car/Boat
Channels	4
Frequency Range	2.402-2.480GHz
Transmission Power	< 20dBm (EU)
RF Protocol	AFHDS 3
Channel Latency	< 13ms
Low Voltage Alarm	< 3.6V
Data Output	Micro USB
Charging Port	Micro USB
Antenna Type	Built-in Single Antenna
Input Power	1S/4.2V Lithium Battery
Online Update	Yes
Range Without Ground Interference	> 300m
Dimensions	129*114*190mm
Weight	520g
Certification	CE, FCC ID: N4ZFG400

注意事项！

开始操作前请务必在 Flysky 官网下载并阅读《免责声明 & 警告》了解安全注意事项，并在 Flysky 官网下载阅读使用说明书。

Flysky 官网地址：www.flysky-cn.com

1. 发射机的天线必须距离所有人员或其他发射机至少 20 厘米的间隔距离。必须将天线安装说明和满足射频讯号辐射的发射机操作条件提供给终端用户和安装人员。
2. 特此,【Flysky Technology co., Ltd】声明无线电设备【Noble(NB4),FG4】符合 RED2014/53/EU.
3. 欧盟 DoC 声明全文可在以下互联网地址：www.flysky-cn.com 获取。

前视图:

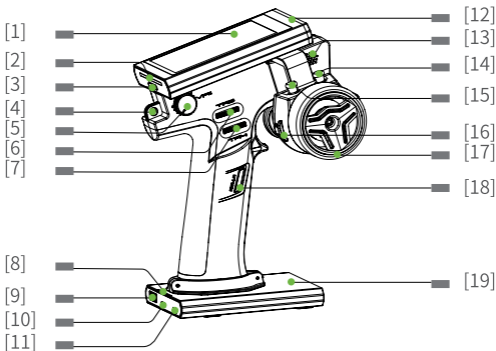

- | | |
|---------------|----------------------|
| [1] 显示屏 | [11] USB 输入、更新程序 |
| [2] 发射机 LED 灯 | [12] 内置天线 |
| [3] 发射机电源键 | [13] 喇叭 |
| [4] 吊环 | [14] TR2(油门微调按键) |
| [5] VR1 | [15] TR1(方向微调按键) |
| [6] TR3 | [16] SW2 |
| [7] TR4 | [17] 手轮 (可旋转 180°) |
| [8] 底座电量指示灯 | [18] SW1 |
| [9] USB 5V 输出 | [19] 可拆卸底座 |
| [10] 底座电源键 | |

后视图:

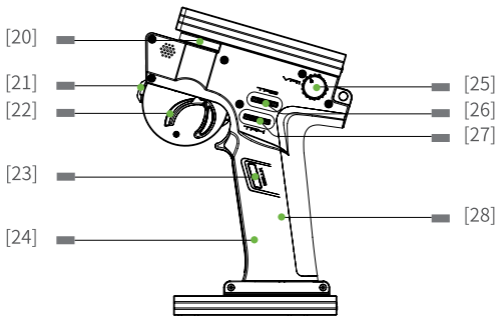

[20] 手轮旋转支架

[21] SW3

[22] 扣机

[23] SW1

[24] 内置电池

[25] VR1

[26] TR3

[27] TR4

[28] 震动马达内置于发射机手柄处 (具体的震动效果可在系统菜单“Vibration”子菜单中设置。)

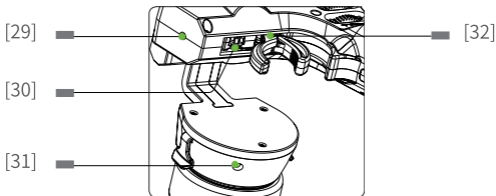

- 注意：调节时请勿将调节螺丝拧出。

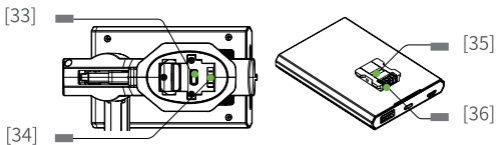

- | | |
|------------------|------------|
| [29] 调节整个扣机结构的行程 | [33] 弹簧卡扣 |
| [30] 调节扣机松紧度 | [34] 电源连接口 |
| [31] 调节手轮松紧度 | [35] 弹簧卡扣槽 |
| [32] 调节扣机尺寸大小 | [36] 电源连接口 |

- 关于 Noble 发射机的更多操作请阅读使用说明书。

开机

1. 检查系统状态，确保：
电池电量充足；
2. 长按发射机电源键，直至屏幕亮起，表示开机。

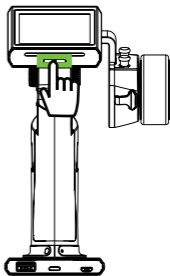



关机

1. 断开接收机电源；
2. 长按发射机电源键，直至屏幕熄灭，表示关机。

! 关闭前，请务必先断开接收机电源，然后关闭发射机。如果强行关闭发射机，将有可能导致遥控设备失控或者引擎继续工作而引发事故。

语言选择

功能设置：

点击主界面  图标，进入功能菜单界面，点击选择进入 [系统设置]，点击 [语言] 进入设置界面，根据需要选择 English(英文) 或中文，点击  退出。

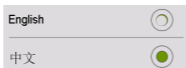





⚠失控保护

该功能用于在接收机丢失信号或失控后，保护模型和操作人员的安全。

失控保护菜单下显示四个通道的列表，如果在通道后显示 [关闭]，表示模型在丢失信号后，该通道的舵机会继续保持失控前的位置继续行驶。如果显示一个百分比，则表示模型在丢失信号后，该通道的舵机会移动到百分比对应的位置，并保持在该位置继续行驶。失控保护功能默认关闭状态。

功能设置：

1. 点击主界面  图标，进入功能菜单界面，选择进入 [接收机设置] 功能，点击 [失控保护 (Failsafe)]，进入设置界面，点击  图标激活失控保护功能；
2. 点击需设置失控保护的通道，进入对应通道设置界面后，点击  图标激活此通道失控保护功能；
3. 移动对应的手轮、扣机或旋钮至所需位置后，点击  保存并退出此界面。

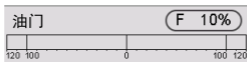

此图表示失控保护状态油门通道输出值为向前 10%

- 每个通道设置失控保护时，均需要点击对应通道界面的  激活此通道失控保护功能；



- 为保证安全，请用户在使用前预先设定好失控保护值

舵机频率

此功能用于调节通道输出控制舵机频率，该功能包括模拟舵机（95Hz）、数字舵机（380Hz）、自定义频率，可根据使用的舵机选择或设置正确的输出频率值，系统默认数字舵机，自定义频率调节范围在 50-400Hz 之间。

功能设置：

- 进入主界面，点击 
- 进入【接收机设置】，点击【舵机响应速度】
- 点击选择模拟舵机、数字舵机或自定义频率
- 如选择自定义频率，请点击屏幕“+”、“-”进行频率调节



 模拟舵机（95Hz）、数字舵机（380Hz）为市场上较通用舵机频率值，故单独设定以使用户快捷操作，为了使舵机正常运行，请先查阅舵机使用说明书确认舵机正确频率，然后通过该功能对舵机频率数值进行更改。

固件更新

此发射机的内置软件程序能够通过使用 USB 线与 windows 计算机连接后进行软件更新升级。一旦此功能被激活后，发射机所有功能将停止工作。为了防止车辆失去控制，请在进入此功能前断开接收机电源。



警告

- 当固件正在更新时请勿断开 USB 线

更新步骤：

1. 下载并打开最新的官方软件；
2. 通过 USB 先将发射机连接至电脑；
3. 点击主界面  图标，进入功能菜单界面，进入 [系统设置] 功能；
4. 点击 [固件更新]，弹出提示界面“进入遥控器更新模式所有功能将停止 确定吗？”，点击 [是] 即可进入更新模式。
5. 在完成以上步骤后，电脑更新软件窗口弹出如下图提示（仅供参考），点击 [Update] 后开始更新。

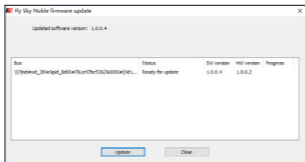



6. 更新完成后，发射机将会自动退出更新状态，进入开机界面。（断开 USB 线连接，以及关闭电脑更新软件）



- 系统更新完成后可能会导致接收机无法连接，此时需要更新高频与接收机

更新高频

更新步骤：

点击主界面  图标，进入功能菜单界面，选择进入 [系统设置]，点击 [高频设置] 进入设置界面，点击 [更新高频] 弹出提示“确定更新高频头？”，点击 [是]，进入升级界面，升级成功后弹出提示“升级成功”，点击  退出。

更新接收机

当发射机更新程序后，为了实现功能的优化，对应的接收机也需要更新程序。

更新步骤：

点击 [接收机设置] 后，点击 [更新接收机]，如果发射机已经对码成功，并且建立连接，则弹出提示 [确定将接收机更新吗？]。点击 [是] 即可将接收机更新；

如果接收机与发射机未建立连接，则弹出提示 [请连接接收机，或使接收机进入强制更新模式]，点击 [是] 进入接收机选择，该发射机提供两种配接收机：FGR4、FGR4S（注：FGR4S 在使用时需竖立摆放），用户可根据实际情况选择需要升级的接收机，点击 [升级] 即可！

使用对码线短接这两个排针可进入强制更新状态

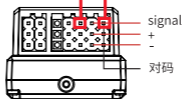

强制更新模式

进入更新后，显示如图画面，进度 100% 时，更新成功。

- 更新接收机前，必须先更新高频。

正在升级 (0%)



对码

本发射机和接收机在出厂前已对码成功。如果您需要对码时，请按照如下步骤进行对码：

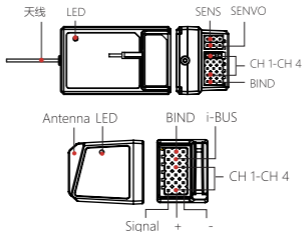

1. 将对码线连接至接收机 BIND 接口；
 2. 将电源线连至接收机任意接口，此时接收机快闪；
 3. 打开发射机进入 [接收机设置]，点击 [对码]；
 4. 对码成功后，接收机指示灯常亮（双向系统）；
 5. 点击退出发射机对码界面，将对码线和电源线从接收机上断开；
 6. 将电源线重新连接至接收机，检查舵机是否正常工作。如需重新对码，请重复以上步骤。
- 此步骤适用于 Noble 与 FGr4 以及 FGr4S 的接收机对码，如您使用的是其他接收机，请进入官网查询对应接收机的使用说明书进行操作。





LED 指示灯

Noble 有两种 LED 指示灯，分别是发射机 LED 灯、底座电量指示灯。

发射机 LED 灯

有五种颜色，分别为红色、绿色、蓝色、黄色、白色，也可以关闭 LED 灯显示。

功能设置：

1. 点击进入主界面  图标，进入功能菜单界面，选择进入 [系统设置 (SYSTEM)] 功能；
2. 点击 [LED]，进入设置界面；
3. 根据需要选择颜色，点击  图标，显示为  表示选择成功，同时发射机 LED 指示灯会显示对应颜色。
4. 设置完成后点击此图标 ，即可退出。



底座电量指示灯

由四个 LED 灯组成，主要用于显示底座的电池电量。

当底座电量低时底座 LED 灯将会仅有一个 LED 灯亮同时闪烁；

当底座正在充电时，LED 灯将会闪烁，同时按照实际电量 LED 灯灯亮个数也会变化。

底座电源键操作：

按下底座电源键，底座电量指示灯亮起即给发射机充电或 USB 输出端口输出 5V 电压，可给外部设备充电。再次长按底座电源键，底座电量指示灯灭同时停止充电。

 请勿同时给发射机及外部设备充电，否则可能影响发射机充电饱和时间，甚至外部设备负载过大时会触发过载保护。

底座

发射机底座可拆卸。

此底座在按压底座电源键后可为发射机供电，也可以通过底座的 USB 输出端为外部电子设备供电。当发射机需要充电时，通过底座 USB 输入端，插入 USB 数据线即可充电。

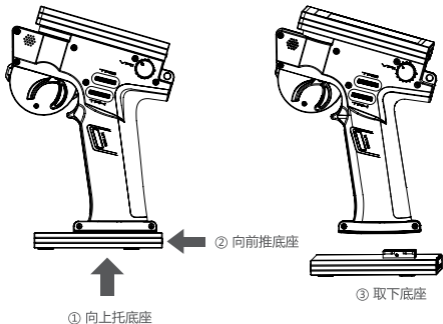

! 建议：Noble 在使用过程中请勿充电。

规格参数

Noble (NB4)

适合模型	车、船
通道个数	4
频率范围	2.402-2.480GHz
发射功率	< 20dBm (EU)
RF 标准	AFHDS 3
通道延时	< 13ms
低电压报警	< 3.6V
数据输出	Micro USB
充电接口	Micro USB
天线类型	内置单天线
输入电源	1S/4.2V 锂电池
在线更新	Yes
空旷无干扰地面距离	> 300m
外形尺寸	129*114*190mm
机身重量	520g
认证	CE, FCC ID: N4ZFG400



FCC ID: N4ZFG400

出版日期 :2019-06-14

Copyright ©2019 Flysky Technology co., ltd

